

V4 | March 2021

ULTRAROOF INSTALLATION GUIDE (NEW)

Dear Customer,

Thank you for choosing the Ultraframe Ultrarroof product.
This guide is designed to make fitting as straightforward as possible.

Before you commence installation of the roof, please take a moment to read the guide.

This guide is written on the basis that a qualified surveyor has undertaken correct checks for the capability / structural performance of any existing framework / walls / foundations to verify they are fit for purpose. Any feedback - positive or negative - is welcomed so we can make our systems even better.

Please contact the Tech Support Team on **01200 452 918**
or email techsupport@ultraframe.co.uk

For everything you need to know about Ultrarroof including guides and installation videos visit

www.ur380info.co.uk

ULTRAROOFF FITTERS TIPS

If this is the first time you're fitting an Ultrarroof we ask you to familiarise yourself with the Installation guide before you start.

Ensure that you have all the key documents outlined on page 10, all the correct tools and safe access equipment, these are outlined on page 3. If you don't have any of the key documents, please call **Technical Support at Ultraframe on 01200 452918 - have your order number handy.**

CONTENTS

	PAGE		PAGE
Tools required / items not supplied	3	Installation - Preparation for 0.13 U-Value	37
Fixing summary	4-9	Installation - Plasterboarding	37-38
Ultrarroof fitters tips	9	Installation - Plasterboarding columns	39
Documentation checklist	10	Installation - Georgian - Roof glass	40-44
Box beam cross section assembly	11	Installation - Lean-to solid	45-50
Product overview / assemblies	12-13	Installation - Lean-to glazed	51-55
Fitting sequence for box beams, OSB boards	14	Installation - Lean-to glazed to adjacent wall	56
Box beam on window frame	15	Installation - Gable end glazed	57-59
Box beam on brick work	16	Installation - Gable apex cover	60
Box beam on brick and window frame	17	Installation - Gable reinforcement	61-62
Installation - Solid - Georgian - Box eaves beam	18-21	Installation - Gable standard soffit	63
Installation - Solid - Georgian - Structural framework	22-23	Installation - Gable extended soffit	64
Installation - Solid - Georgian - Panel sequence	23-24	Installation - Box beam on columns	65
Installation - Solid - Georgian - OSB boarding	25	Installation - Tudor finishing	66-67
Installation - Georgian - Structural framework	26-27	Installation - Beam jointing post	68-69
Installation - Georgian - Water proof membrane	27-28	Installation - Soil Pipes	70-72
Installation - Georgian - Ultratile and hip spines	29-33	Installation - Waste Pipes	73
Installation - Georgian - Ridge and top caps	34	Installation - Hip assembly variable pitch	74
Installation - Georgian - Fascia soffit and guttering	35	Installation - Lean-to hipped end/ Wraparound	75
Installation - Down lights	36		



FITTERS:
Look out for this registration form and pass to the homeowner please

TOOLS REQUIRED



NOT SUPPLIED:

Several items are not supplied by Ultraframe as they are easier and cheaper to source locally. These are:-

- Velux roof windows and EDL flashing kits (the roof arrives prepared for Velux). NOTE: 15 degree minimum pitch
- Anchor or Masonry fixing bolts to host wall
- 12.5 foiled backed plaster board and skimming beads
- LED (fire resistant) lighting
- Internal 20mm x 50mm, 25mm x 50mm timber plastering battens
- Timber support props (75mm x 50mm) beam support
- Structural support (available from Ultraframe)
- Frame to boxbeam fixings
- Mineral wool/ expanding foam (for filling small apertures)

HEALTH & SAFETY

Site safety is paramount. The Construction (Design & Management) Regulations 2015 apply to the whole construction process, on all construction projects from concept through to completion. Compliance is required to ensure construction projects are carried out in a way that secures health and safety. The installation company shall be responsible for the safety of all of the fitting team, the customer and members of the public.

The Surveyor should have carried out a written risk assessment to reduce risk on site and this should have been discussed with you (the installer) prior to starting.























Please use safe working platforms/ scaffolding all round and ladders that comply with BS EN 131. Always use equipment in line with manufacturers recommendations. Personal Protective Equipment – such as goggles, mask and ear defenders – should be used when, for example, grinding out for the flashing.

Downlighters must be LED IC (Insulation Contact) fire rated.

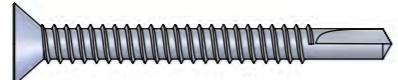
ULTRAROOF FIXING SUMMARY

PLEASE USE THE SUPPLIED FIXINGS WHEN INSTALLING THE ULTRAROOF TO ENSURE A SECURE AND CORRECT INSTALLATION.

FIXINGS SUPPLIED Below shows the various fixings supplied for an installation of an Ultraroom. These should be found in the box containing this document.

NRBA 012 4.8 x 32 Phillips CSK HD S/Drill	 	PHILLIPS SCREWDRIVER BIT
WPDS 020 3.5 x 50 Dry wall pozi countersink screw	 	PHILLIPS SCREWDRIVER BIT
NRPS 050 4.0 x 25 Deck-tite pozi countersink screws	 	POZI SCREWDRIVER BIT
NRTS 050 4.2 x 25 wafer head Self drilling screws	 	PHILLIPS SCREWDRIVER BIT
RRX 025 5.0 x 50 C'SNK pozi heco fix wood screw	 	POZI SCREWDRIVER BIT
NRRSA 005BL 5.5 x 90 Hex washer head tek screw	 	M8 HEX SCREWDRIVER BIT
NRES 004 4.8 x 32 pan head self drill	 	PHILLIPS SCREWDRIVER BIT
NRSF 012 4.8 x 38 pan head self drill	 	PHILLIPS SCREWDRIVER BIT
WPCS 020 4.8 x 38 self drilling C'SNK screw	 	PHILLIPS SCREWDRIVER BIT
CHAA006 4.0 x 13 self drill wafer head	 	PHILLIPS SCREWDRIVER BIT
NRTT001 Tile screw fixing tool		
NRTF 050 4.2 x 25 Wafer head piercing point screw	 	PHILLIPS SCREWDRIVER BIT

FIXING LOCATION SUMMARY

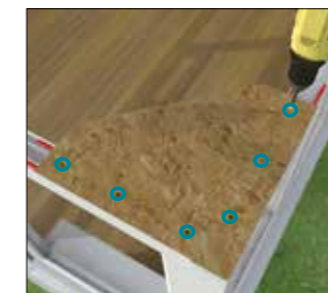

Fixing support shelf to existing frames

6 fixings per corner



Securing corner cleats

12 per cleat, 6 through pre drilled holes, 6 through gutter support channel



Fixing hanger bracket to wall

4 fixings per bracket



New internal 90° box beam cleat

18 fixing per cleat

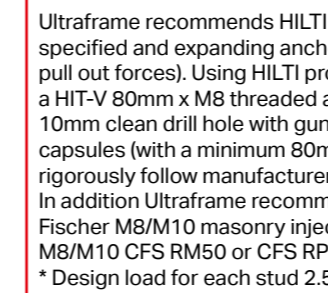

New extended external box beam cleat

12 fixing per cleat



Fixing support props to beam

2 fixings per prop



New extended external box beam cleat

4 fixing per hip

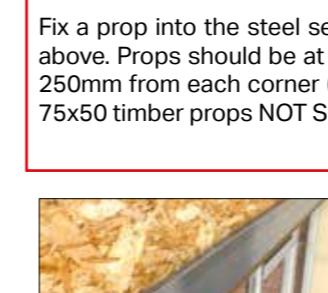

Fixing through head of window frame into beam

200mm from corner, 450mm CTRS



Fixing through head of window frame into beam

200mm from corner, 450mm CTRS



Fixing set out staff

2 per cleat

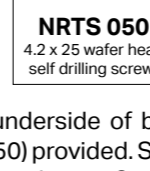

Fixing beam to corner

6 fixings per corner

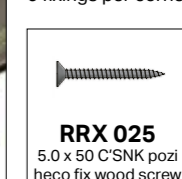

With set out staff flush with underside of beam, fix to face of beam using 2 x (NRTS050) provided. Staff set-out cleat fixed to internal face of box beam. Once fixed the staffs will ensure beams remain parallel to each other.

FIXING LOCATION SUMMARY



Fixing wall brackets to the beam

6 fixings per bracket



RRX 025
5.0 x 50 C'SNK pozi
heco fix wood screw



Fixing starter bar extrusions to the wall

Within 200mm of ridge and eaves another equidistant

NOT SUPPLIED

Ultraframe recommends HILTI chemical anchors where specified and expanding anchors in other locations (to resist pull out forces). Using HILTI product codes/descriptions, use a HIT-V 80mm x M8 threaded anchor (stud*) fastened into a 10mm clean drill hole with gun injected mortar or adhesive capsules (with a minimum 80mm embedded) - always rigorously follow manufacturers guidance www.hilti.com
In addition Ultraframe recommends the following alternatives; Fischer M8/M10 masonry injection anchor FIS V
Rawl Fixings M8/M10 CFS RM50 or CFS RP30
* Design load for each stud 2.5k



Fixing adjustable rear ridge bracket

2 fixings per bracket



NRTF 050
4.2 x 25 wafer head
piercing point screw



Fixing ridge bracket

2 fixings per bracket

NOT SUPPLIED

Ultraframe recommends HILTI chemical anchors where specified and expanding anchors in other locations (to resist pull out forces). Using HILTI product codes/descriptions, use a HIT-V 80mm x M8 threaded anchor (stud*) fastened into a 10mm clean drill hole with gun injected mortar or adhesive capsules (with a minimum 80mm embedded) - always rigorously follow manufacturers guidance www.hilti.com
In addition Ultraframe recommends the following alternatives; Fischer M8/M10 masonry injection anchor FIS V
Rawl Fixings M8/M10 CFS RM50 or CFS RP30
* Design load for each stud 2.5k



Fixing ridge bracket

8 fixings per bracket



NRTF 050
4.2 x 25 wafer head
piercing point screw



Fixing external clips

10 fixings per full clip
5 fixing per half clip



WPCS 020
4.8 x 38 self drilling
C'SNK screw



Fixing internal clips

4 fixings per full clip
2 fixing per half clip



WPDS 020
3.5 x 50 Dry wall
pozi countersink
screw



Fixing internal clip to box beam shelf

2 fixings per full clip



CHAA 006
4.0 x 13 self drill
wafer head



Fixing internal clip to shelf

2 fixings per full clip



CHAA 006
4.0 x 13 self drill
wafer head

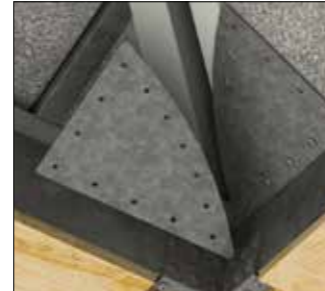

Fixing internal hip retaining plates

9 fixings per plate



CHAA 006
4.0 x 13 self drill
wafer head

FIXING LOCATION SUMMARY



Fixing internal lower hip brace plate

4 fixings per plate



CHAA 006
4.0 x 13 self drill
wafer head



Fixing internal upper hip brace plate

4 fixings per plate



CHAA 006
4.0 x 13 self drill
wafer head



Fixing internal jack rafter connection plate

4 fixings per plate



CHAA 006
4.0 x 13 self drill
wafer head

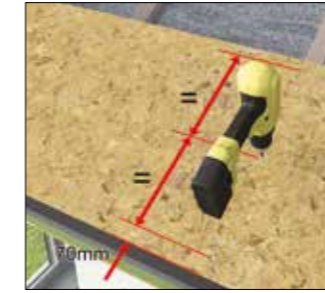

Fixing OSB to external panel clips

24 fixings per full panel



NRPS 050
4.0 x 25 deck-tite
pozi countersink
screws



Fixing steel hip plates

300mm centres (pre drilled holes)



NRTS 050
4.2 x 25 wafer head
self drilling screws



Fixing Aluminium ridge plate

Pre drilled holes



NRTS 050
4.2 x 25 wafer head
self drilling screws

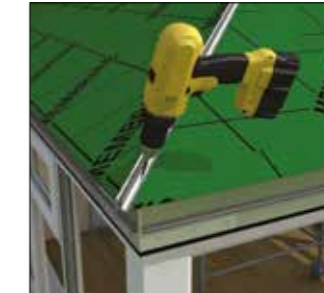

Fixing hip spines

500mm centres per side



NRTS 050
4.2 x 25 wafer head
self drilling screws



Fixing Ultratile starter strip

Fix through all available holes



NRTS 050
4.2 x 25 wafer head
self drilling screws



Fixing Ultratile panel

11 per full tile



NRTF 050
4.2 x 25 wafer head
piercing point screw



Fixing ridge top cap

Pre drill MAX 750mm CTRS



NRRSA 005BL
5.5 x 90 Hex washer
head tek screw



Fixing end caps

Screw port



NRES 004
4.8 x 32
pan head self drill



Fixing glazing bar shoes at box beam

Pre drilled holes



NRTS 050
4.2 x 25 wafer head
self drilling screws

FIXING LOCATION SUMMARY FOR GLAZED ROOFS

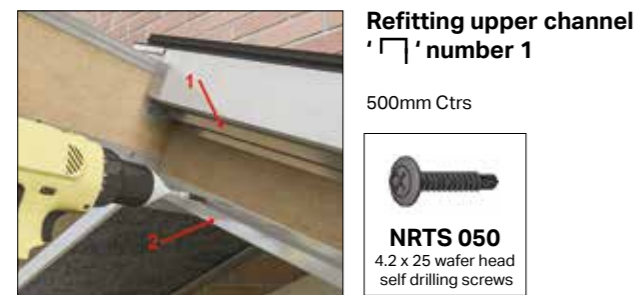
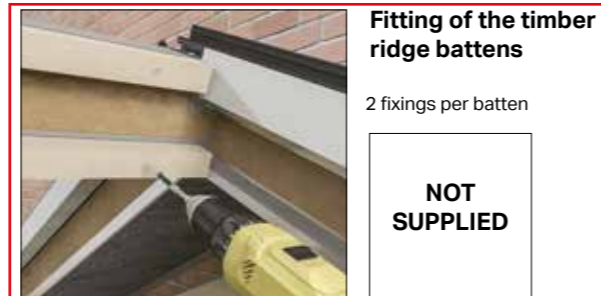
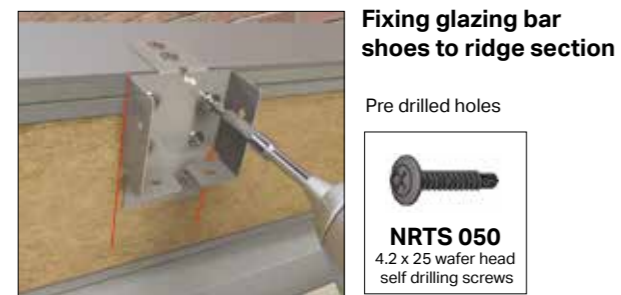

FIXING LOCATION SUMMARY FOR GLAZED ROOFS

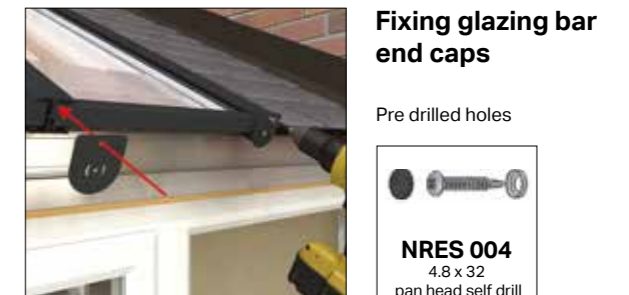

Here are some top tips from Ultraframe to help your installation run smoothly.

1. Ensure the beams are laid on top of the frames in the correct order. The correct 'fitting sequence' is shown on page 14.
2. When positioning the beams check the dimensions match the critical dimensions sheet supplied with the roof. Start by ensuring the beams that attach to the house wall are parallel and the correct distance apart. Ultrarof will accommodate slightly out of square bases and frames. Please call Technical Support on 01200 452918 for technical advice if this is the case.
3. In order to ensure the stability of the beam it needs to be sufficiently supported. Details are shown on page 19 of this guide.
4. Always use the fixings, sealants and adhesives specified within the installation guide in order to ensure the strength and water tightness of the roof.
5. Don't forget to prop the ridge as shown on page 22, step 32.
6. **Do not cut the panel strapping until all panels fully installed.**
7. When fitting the panel clips to the box beam, ensure that the lower end of the clip extension rests/aligns with the edge of the aluminium gutter support channel extrusion on the front of the box beam. This will ensure the OSB is in the correct position. See detail on page 24, step 48.
8. Start by placing the OSB boards next to the box beam first. Work your way around the box beam with the OSB before working your way up to the ridge. Only remove the props once the OSB boards and steel hip plates are fixed in place.
9. The waterproof membrane can be fitted when damp, but always remove surface water before fitting if it's been raining. 100mm overlap is sufficient on the roof surface with 150mm lapping up the wall.
10. Always use tile fixing tool provided (NRTT001). This will prevent over tightening.
11. **The tiles are designed for expansion and contraction. DO NOT BE TEMPTED TO FORCE THE TILES TOO CLOSE TOGETHER. Always work to the insertion lines** ensuring the spaces between the tiles are even across the roof. Use the **starter tile strip** to guide you and refer to the tile leaflet included for further information see page 29.
12. Look out for the handy guides supplied with products for extra tips on fitting.

DOCUMENTATION CHECKLIST - SENT WITH EACH ROOF

Check you have:

1. Critical set out dimensions
2. Confirmation of roof order
3. OSB layout
4. Tile layout
5. Panel layout
6. Modesty panel layout
7. Component location plan
8. Ultrarroof component box list

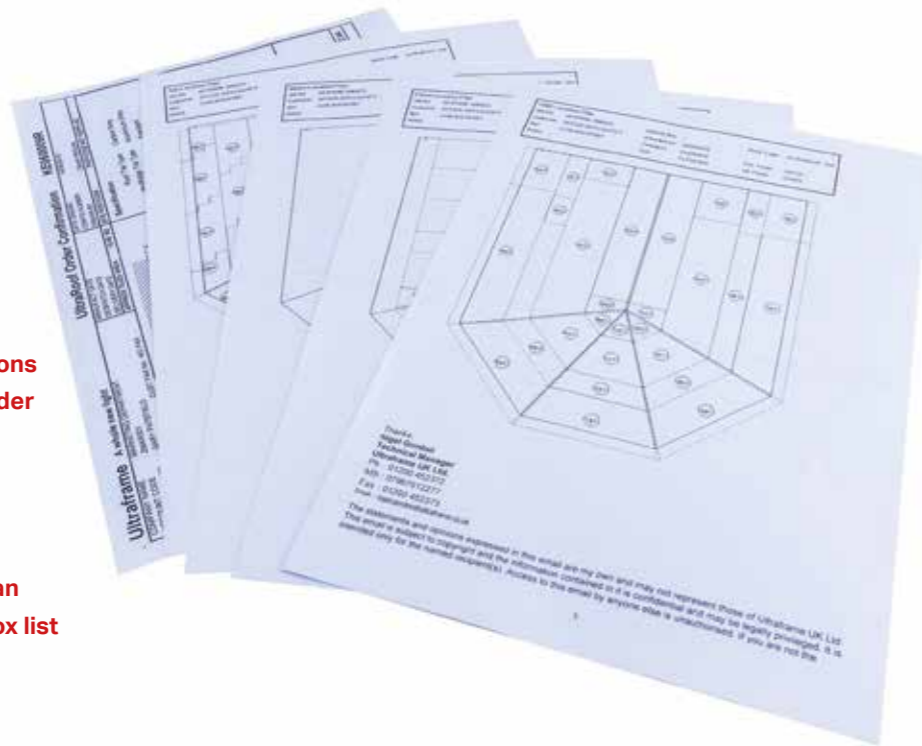

PRE-INSTALLATION CHECKS

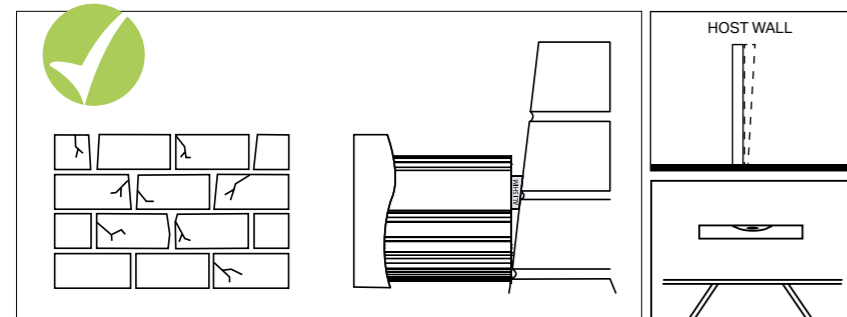

Check the condition of the host wall as this may affect the quality of the final installation. Check the host wall is plumb - any running in/or out should have been accounted for by the surveyor. If not, the ridge and starter bars may require packing out with aluminium shims. Correct alignment in this area is critical to a successful installation - Plumb frames/level ridge. Only use the specified fixings - never be tempted to substitute alternative sizes/gauges.

General points

Choose a suitable area for unpacking the components and always check them before fitting. Any claims for missing or damaged parts are only accepted in line with our standard terms and conditions of sale, 48 hours from delivery.

Careful consideration should be given to the safe disposal of all packaging – Ultraframe packaging is predominantly made from recycled materials and can be readily recycled.

Product

The Ultrarroof kit is supplied with a location plan and, of course, this installation guide. The location plan is used to match individual components to their respective position on the roof.

The Superstructure

Check the side frames are level all round. Before starting to install the Ultrarroof, please check the condition of the host wall and whether it's plumb – depending upon what you find, these conditions can seriously affect the final integrity of the roof.

BOX BEAM CROSS SECTION ASSEMBLY

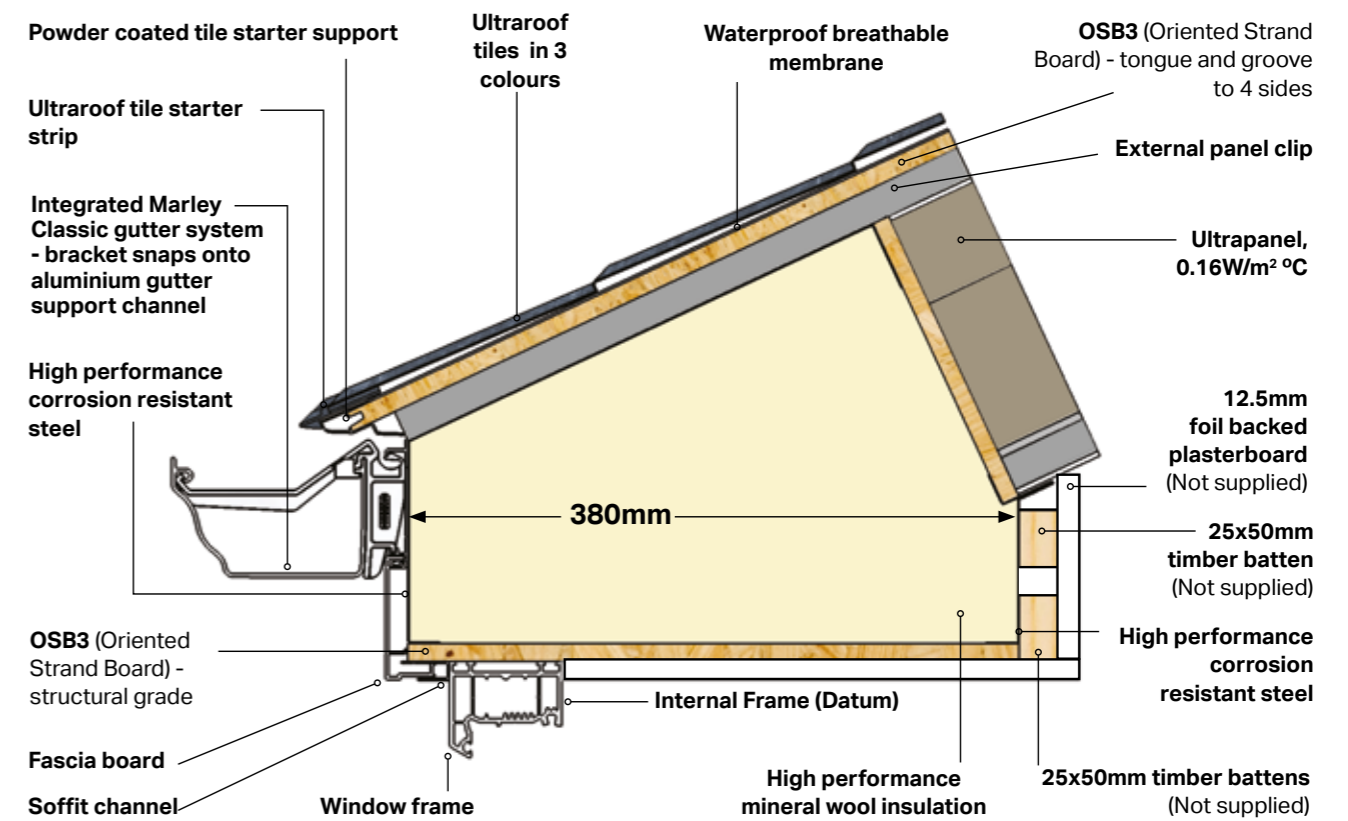

40mm Standard Soffit
NOT SUITABLE FOR SUPER-INSULATED COLUMNS

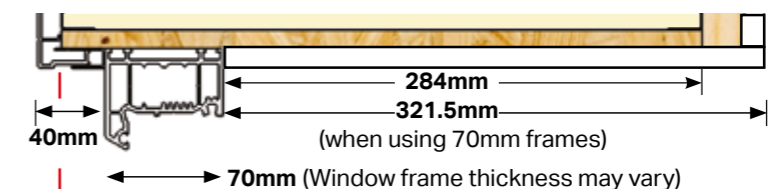

Box beam overhang set 26mm from outer face of 70mm frame

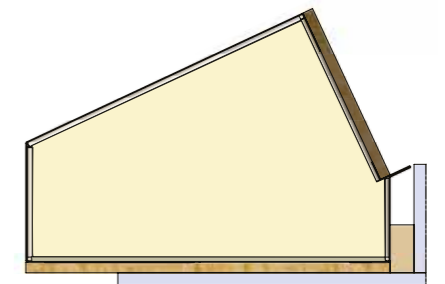

151.5mm Extended Soffit
MUST BE USED ABOVE SUPER-INSULATED COLUMNS

Alternative (only option if sat on super-insulated columns) - see Appendix 1.

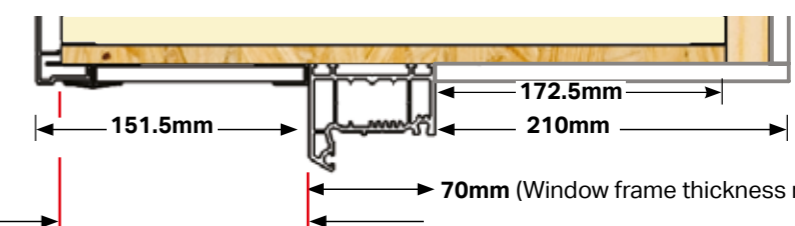

Box beam overhang set 137.5mm from outer face of 70mm frame

PRODUCT ASSEMBLIES

Beam glass



Beam solid

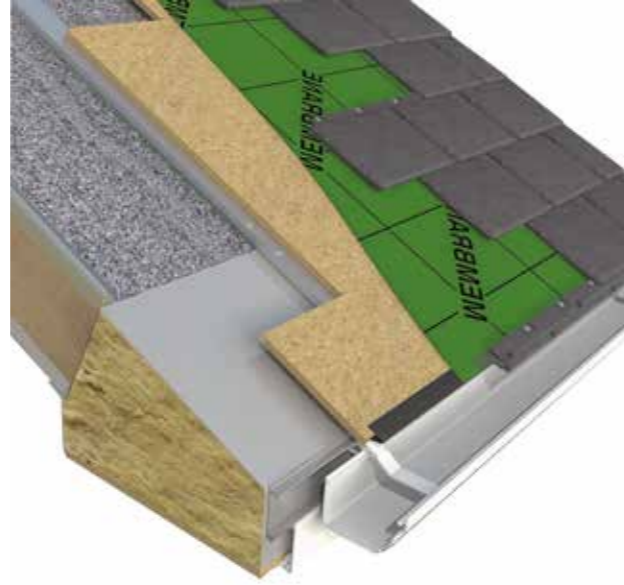

Ridge solid to glass

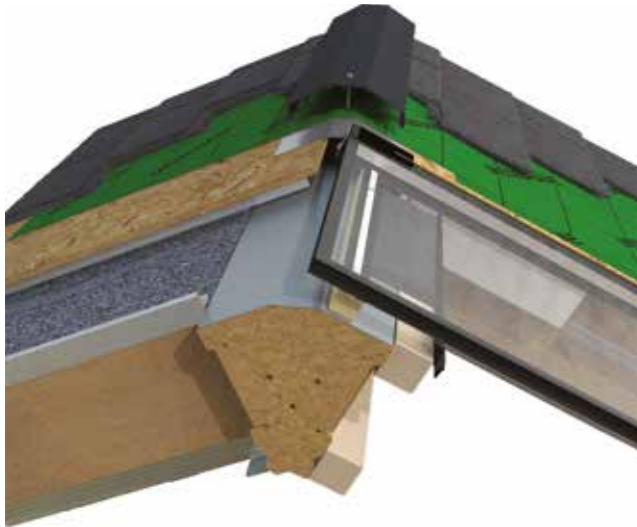

Ridge solid to solid

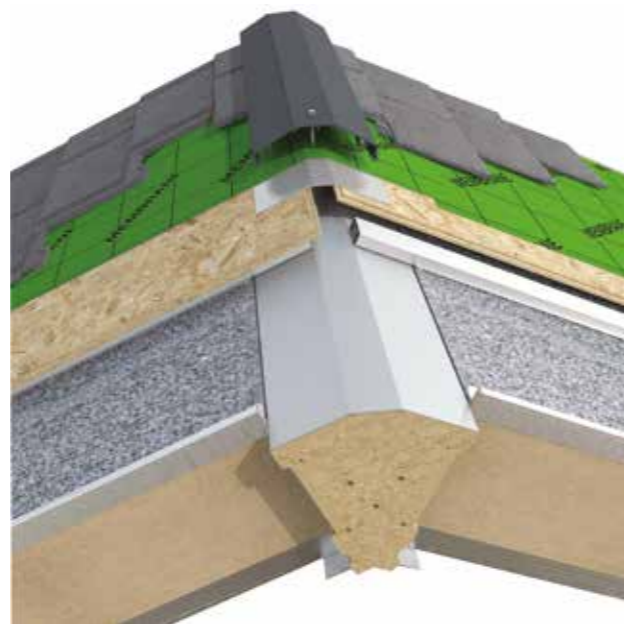

Ridge glass to glass

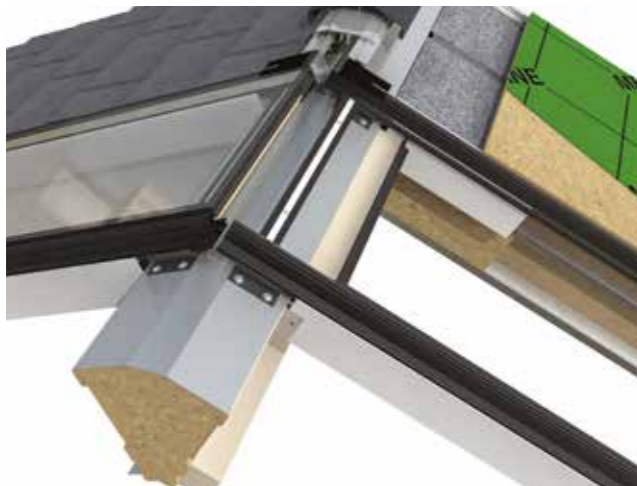

265mm box gutter solid

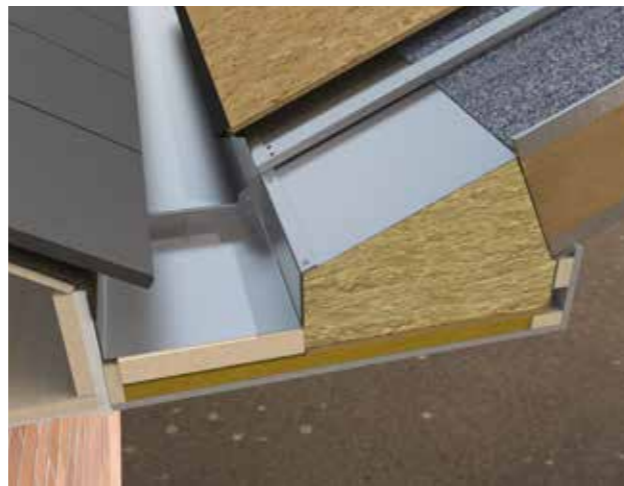

PRODUCT ASSEMBLIES

265mm box gutter glass

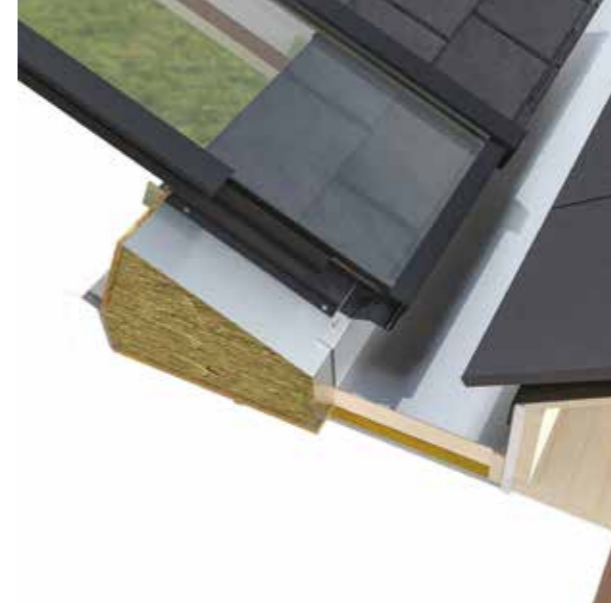

Tapered box gutter



Wallplate glass



Wallplate solid



Bars



Gable extended



Lean to roof gable end frame stiffener is **NOT** supplied as standard. Must be requested if required (for example above door openings). Please refer to Ultraframe Technical Department if fitting bi-folds to gable ended or gable ends on lean-to roofs.

Lean to only

Lean to gable stiffener

FITTING SEQUENCE - BOX BEAMS / OSB / PANELS

IMPORTANT: FOLLOW THE FITTING ASSEMBLY SEQUENCE

KEY: OSB BOX BEAM

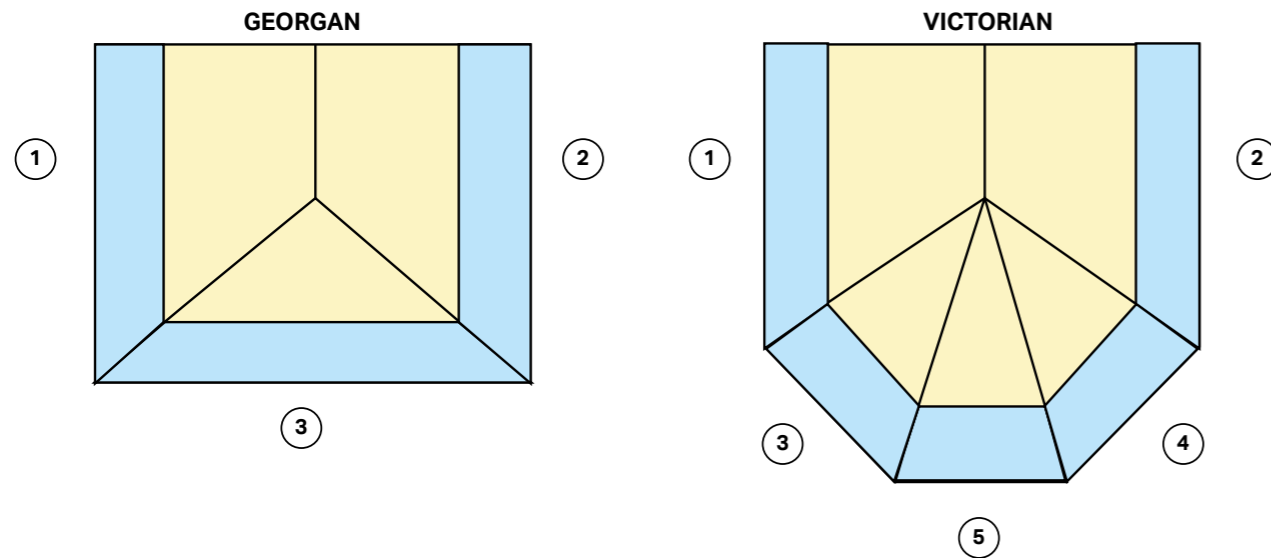

BOX BEAM SUPPORT SHELF GEORGIAN STANDARD SOFFIT

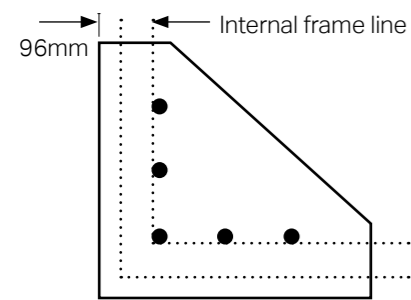

GEORGIAN EXTENDED SOFFIT

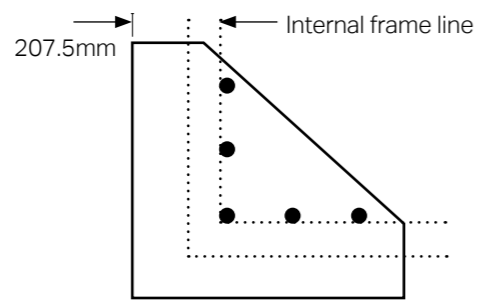

PANEL INSTALLATION SEQUENCE

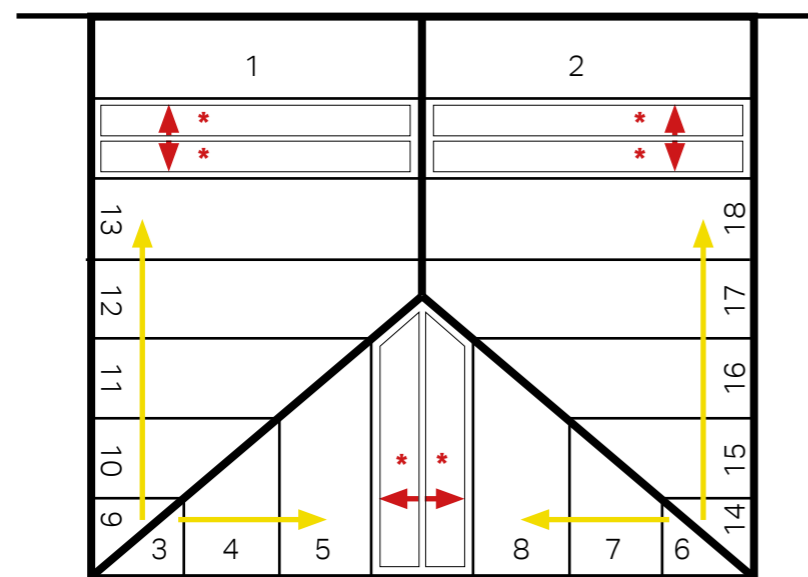

INSTALL YELLOW LABELLED PANELS FIRST.



* = ALL RED TOLERANCE PANELS EXPAND OUTWARDS AND ARE INSTALLED LAST

BOX BEAM ON WINDOW FRAME

The most common kind of situation for installing an Ultrarroof will be existing conservatory roof replacement. This means that the roof will fix to the top of the window frames of the original conservatory. The details for positioning the box beam to the top of window frames as shown below.

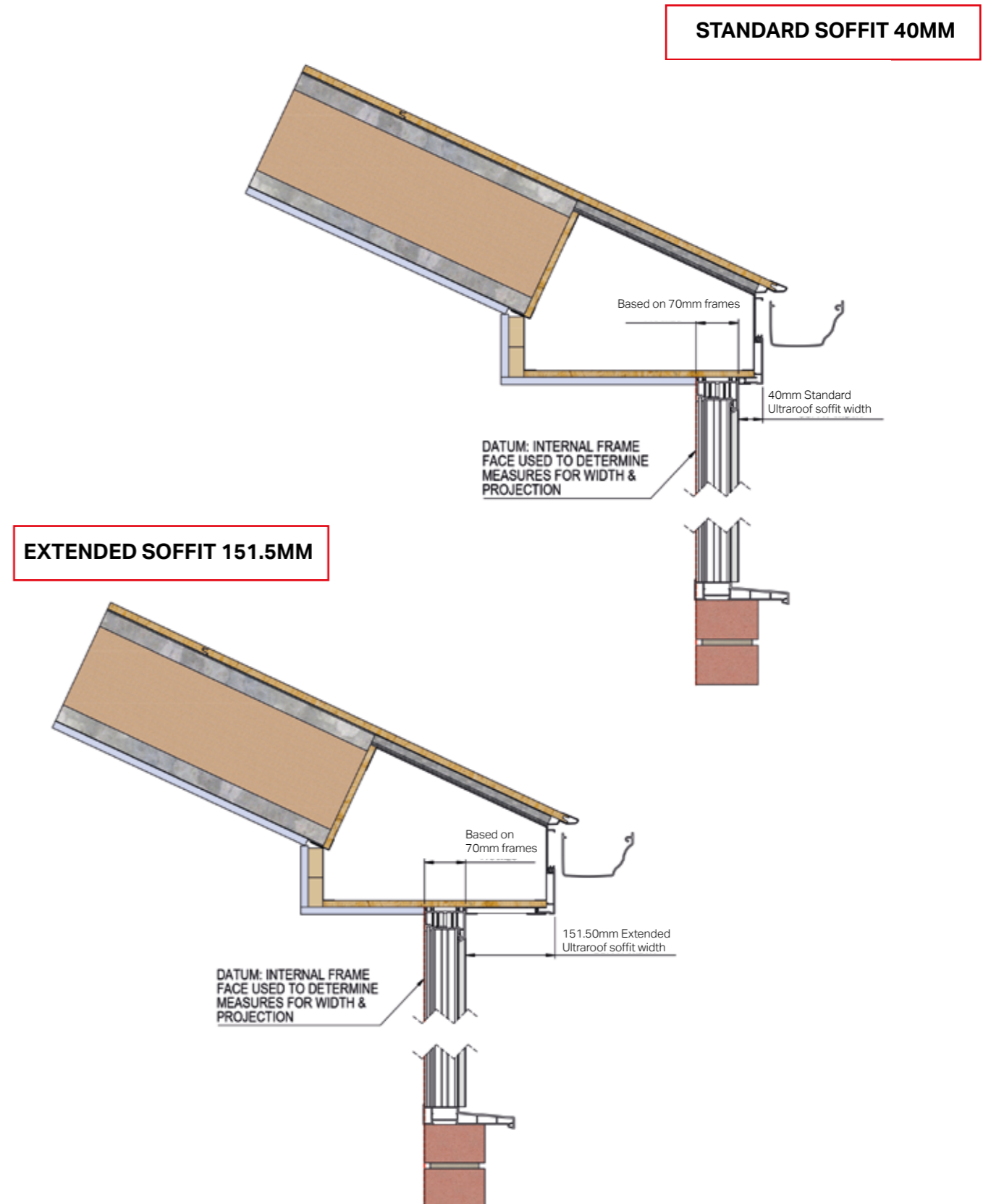

STANDARD SOFFIT 40MM

EXTENDED SOFFIT 151.5MM

BOX BEAM ON BRICK WORK

A common instance with Ultraroom will be that it is sat on brick work for support. If this is the case there are different details of how the roof sits on the brickwork and depending on which of these is required give different results. Below contains the details for positioning the box beam to the top of solid brick work.

OPTION 1 - STANDARD SOFFIT WITH BRICK

ALIGNING BOX BEAM WITH INTERNAL BLOCK FACE

FOR THIS BRICKWORK OPTION - SPECIFY ROOF AS 'EXTENDED SOFFIT' AND DECREASE SIZE OF ROOF BY 25mm (PER SIDE)

NOTE: DO NOT ALTER PROJECTION AT GABLE.

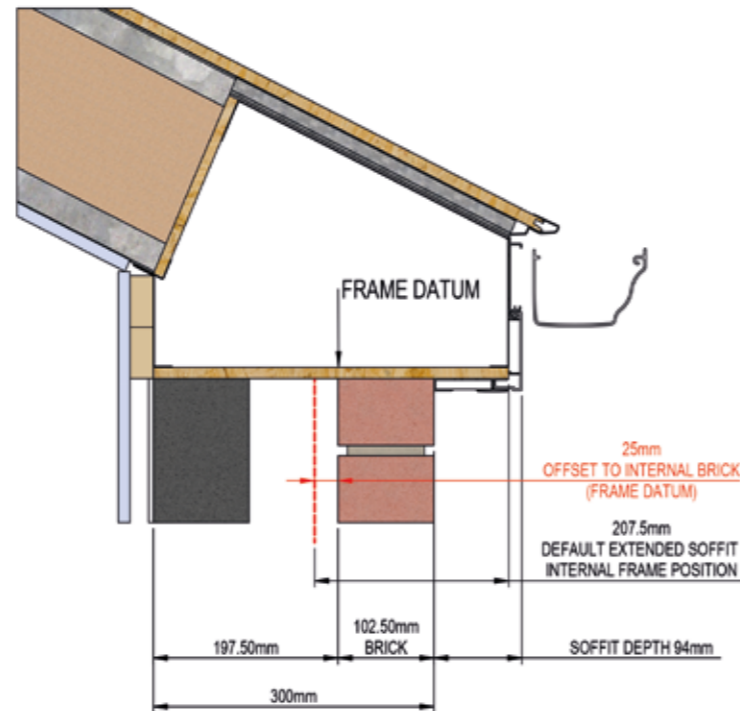

OPTION 2 - EXTENDED SOFFIT WITH BRICK

MAINTAINING INTERNAL SOFFIT WIDTH WHEN SAT ON BRICK WALL

FOR THIS BRICKWORK OPTION - SPECIFY ROOF AS 'STANDARD SOFFIT' AND DECREASE SIZE OF ROOF BY 197.5mm (PER SIDE)

NOTE: DECREASE GABLE PROJECTION OF ROOF (WHERE APPLICABLE) BY 200mm.

Notes:

- Wall straps fixed to underside of the beam and 1m down face of blockwork at 2m centres.
- Fit 25mm insulated plasterboard PL4015 to wall to prevent thermal bridging.
- 12.5mm plasterboard on adhesive dabs to the remainder of the wall.
- Two rows of creasing tiles with staggered joints bedded in mortar with tile slips as required.
- Continuous DPC run across the cavity closer, up the face of the corner post and taped to the top surface.
- 70mm PVCu corner post cladding filled with insulated.
- Weep holes at base of wall 1.2m centres.

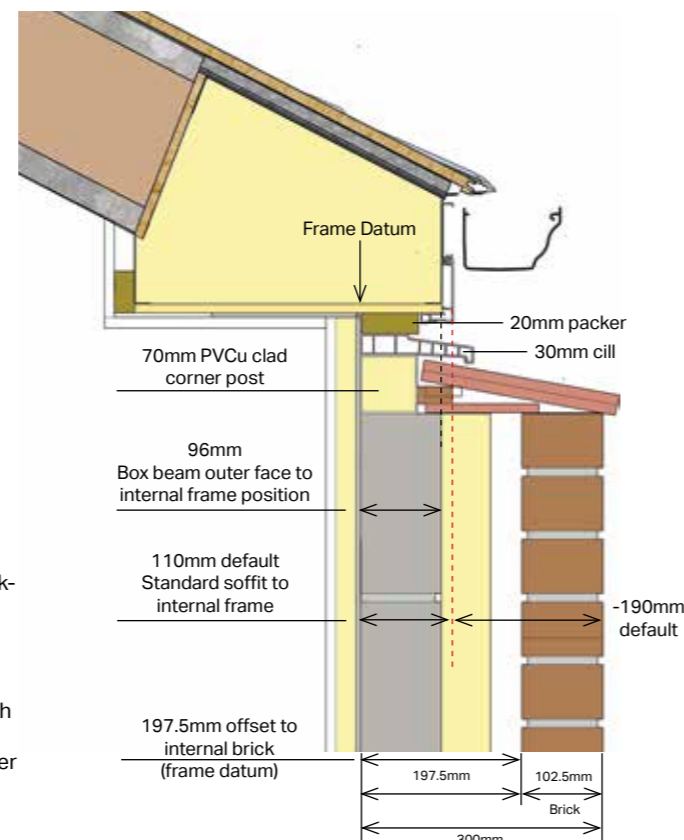

BOX BEAM ON BRICK AND WINDOW FRAME

Some situations will have a mix of window frames and brickwork that will support the length of the box beam. Below contains the details for positioning the box beam to the top of window frames with brick work.

OPTION 3 - BOX BEAM ALIGNING WITH BRICK FACE

IF MAINTAINING THE STANDARD SETOUT WHEN SAT ON A BRICK WALL A CILL MUST BE INCLUDED

FOR THIS BRICKWORK OPTION - SPECIFY ROOF AS 'STANDARD SOFFIT' - NO NEED TO MODIFY SIZE.

NOTE: DO NOT ALTER PROJECTION AT GABLE.

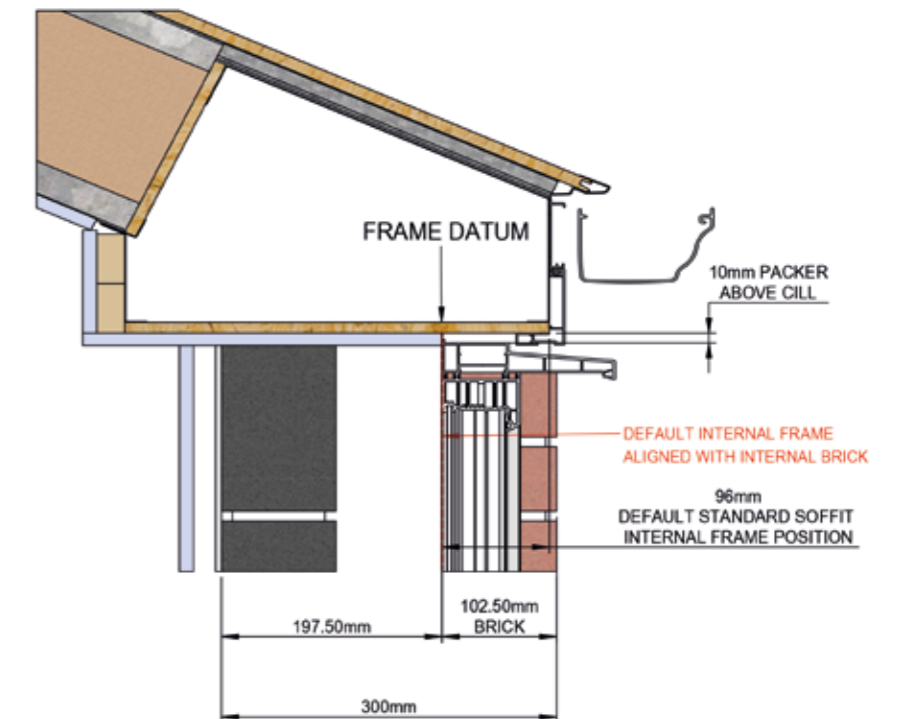

OPTION 4 - BRICK WORK ALIGNING WITH INTERNAL FRAME DATUM

ALIGNING 40mm SOFFIT WITH EXTERNAL BRICK FACE

FOR THIS BRICKWORK OPTION - SPECIFY ROOF AS 'EXTENDED SOFFIT' AND DECREASE SIZE OF ROOF BY 79mm (PER SIDE)

NOTE: DO NOT ALTER PROJECTION AT GABLE.

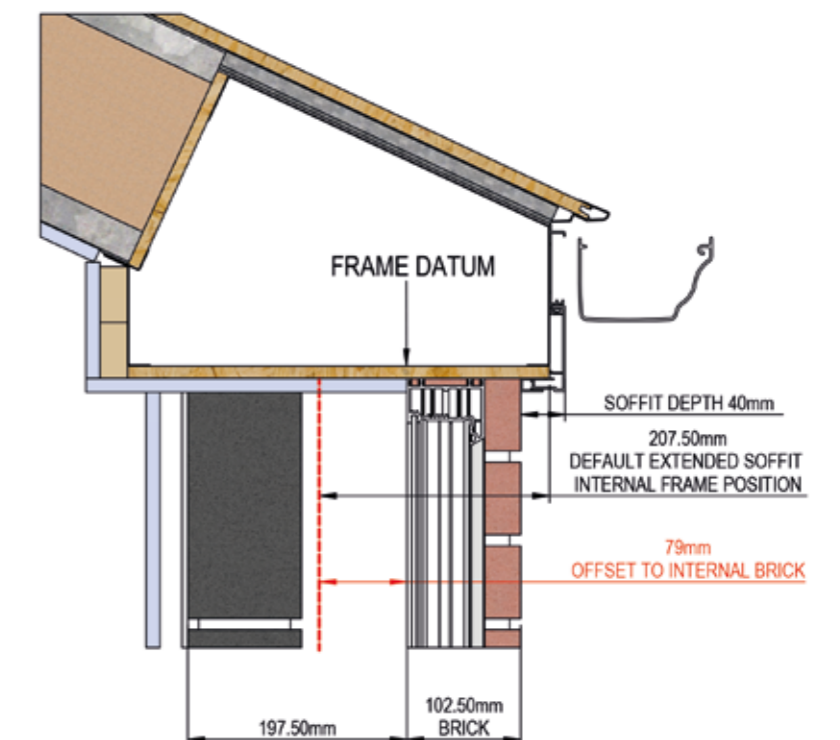



If replacing an existing roof fold back the flashings, safely remove the existing roof and recycle it. If plastered, certain areas will need removing. Fixed light sealed units will need to be removed to allow fixing of box eaves beam. Remove old silicone from head of all frames. NOTE: If fitting onto super-insulated columns refer to page 62.



Using low modulus neutral clear silicone, apply to the underside of the OSB beam support shelf. Then locate the support shelf's (NRSS 090) to the front corners.



Secure support shelves to frames with 6 x fixings (3 each side) 4.8 x 32mm Phillips counter sunk self drill screw (NRBA 012).



Timber positioning spacers attached to underside of support shelves. Ensure these abut internal frame (also shown below).

FOR ROOF WITH VARIABLE PITCH PLEASE TURN TO PAGE 74

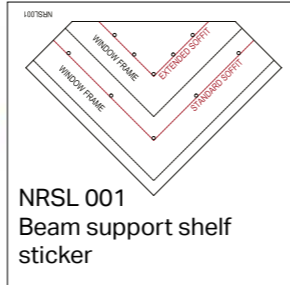

Now fit the NRWB001 box beam wall brackets - one to each side - Bracket sits 8mm inside internal frame line and is set 9mm above window frames (measured to underside of bracket). Remove any interfering plaster work. Bracket must go back to host wall. Not required if sat on masonry, galvanised straps to be used (NOT SUPPLIED).

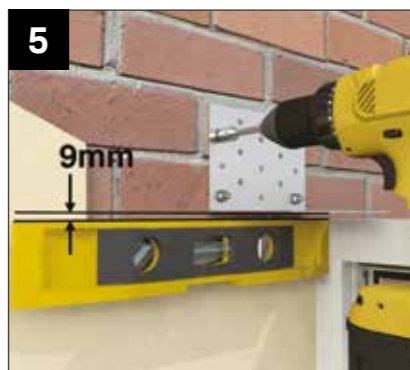

Mark positions for resin anchors (NOT SUPPLIED) appropriate to substrate. Try to fix into solid masonry - 4 fixings. NOTE: The positioning of this bracket may differ. Prior to fixing the bracket ascertain by levelling the high point as all box beams need to be perfectly level (see step 8).

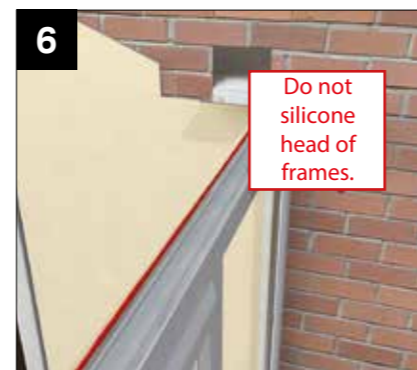

Ensure frame heads are clean and free of silicone, this will allow easy positioning of the box beams.

READ BEFORE FITTING

BEAMS AND RIDGE MUST BE PROPPED/SUPPORTED THROUGHOUT THE INSTALLATION

SEE GUIDE BELOW FOR DETAILS OF PROPS/SUPPORT.

DO NOT REMOVE ANY PROPS UNTIL THE OSB AND STEEL HIP PLATES ARE FULLY FIXED INTO PLACE.

PROPS/ SUPPORTS MUST BE POSITIONED 250mm FROM CORNERS AND MAX 2000mm CENTRES AT THE PROP LOCATION MARKS, PROPS NOT REQUIRED AT HOST WALL (REAR L BRACKET POSITION)

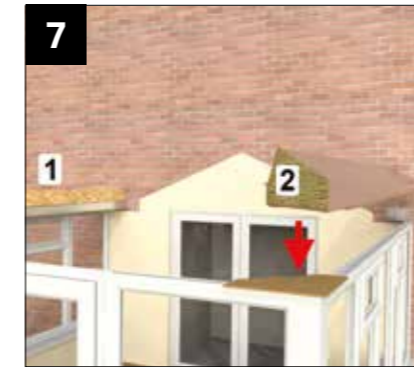

Check page 14 for box beam assembly sequence. Lift side beam 1 into position (2 man lift). Set the beam 10mm away from host wall. Position side beam 2. Again 10mm away from host wall. Check box beam overhang on page 11 and below.

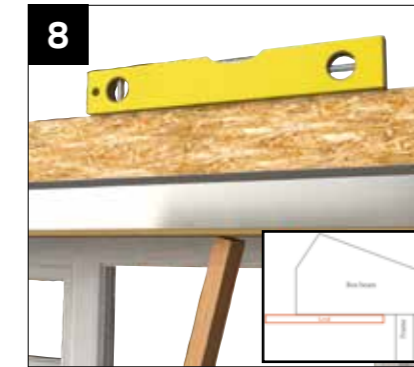

Check the beam is level. Pack off top of frames if necessary. Insert a support prop under the beam. Adjust the height of the prop to ensure the beam is level in length and side to side. (see inset).



Fix a prop into the steel section of the beam as shown above. Props should be at max 2000mm centres within 250mm from each corner (prop fixings NOT SUPPLIED) 75x50 timber props NOT SUPPLIED.

STANDARD 40MM SOFFIT = 26MM OVERHANG
EXTENDED 151.5MM SOFFIT = 137.5MM OVERHANG

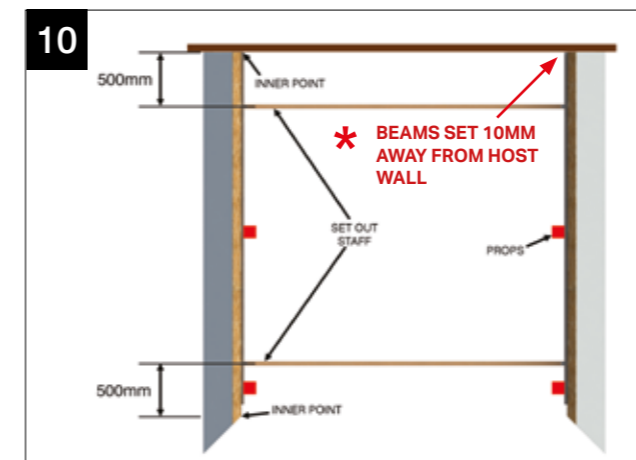

EXAMPLE
Above is a typical 4m x 4m layout, this shows positions of 75mm x 50mm support props and set out staff.
* NOTE: A 10mm thick OSB spacer is attached to beam face this ensures beam is set 10mm away from host wall.



With set out staff flush with underside of beam, fix to face of beam using 2 x (NRTS050) provided. Staff set-out cleat fixed to internal face of box beam. Once fixed the staffs will ensure beams remain parallel to each other.

GEORGIAN INSTALLATION - SOLID ROOF - BOX EAVES BEAM



Width of set out staff matches size given on critical dimension sheet. Pushing or pulling a beam will move adjacent beam the same distance. **Equalise soffit overhang.** Finally check diagonals are equal.



Having installed side beams lift the front beam into position, beam 3. Prop and level beam 3. **NOTE: Refer to page 74 when installing beams with a pitch difference.**



Once the beams have been propped and are level, check the rear L brackets and pack if required.

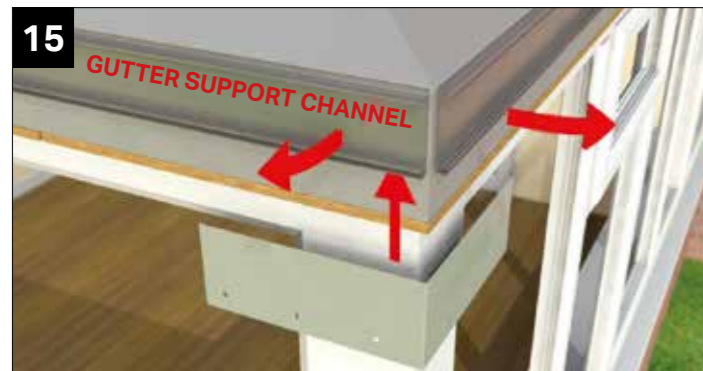

Gutter support channel extrusion is factory fitted but ease out both sections and slide external cleat behind.



Line up bottom of the cleat with the bottom edge of the steel using (CHAA 006) fixings, fit 12 per cleat, 6 in predrilled holes, 6 through gutter support channel extrusion (screws provided).

CHAA 006
4.0 x 13
self drill
wafer head

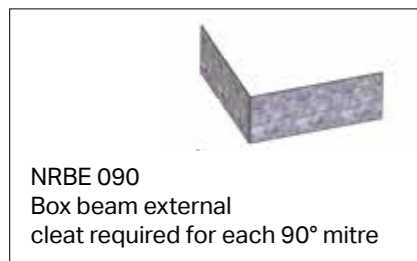

NRBE 090
Box beam external
cleat required for each 90° mitre

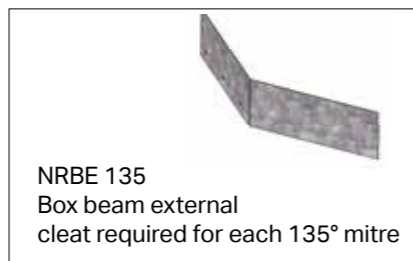

NRBE 135
Box beam external
cleat required for each 135° mitre

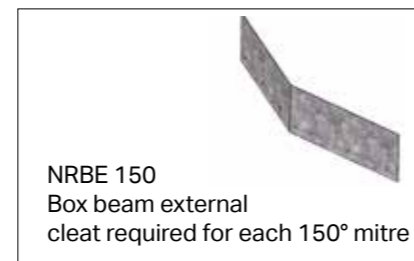

NRBE 150
Box beam external
cleat required for each 150° mitre



Use expanding foam where two beams join to seal any gaps between them.



Then attach top box beam cleat (one to each corner) - these cleats are specific to the roof pitch. Lay over the mitred joint and position so that the top edge abuts the angle. Then fix using 12 x 4.0 x 13mm wafer head self drilling screws (CHAA 006) provided.

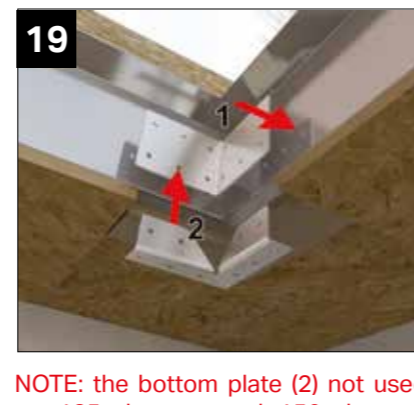

NOTE: the bottom plate (2) not used on 135 degrees and 150 degrees faceted roofs. Place 1 behind 2 before fixing into position using 18 x 4.0 x 13mm (CHAA 006) provided.

GEORGIAN INSTALLATION - SOLID ROOF - BOX EAVES BEAM



The screws to the underside not accessible when box beam sat on brickwork or super insulated columns.

NOTE: These internal brackets NOT used on variable pitched roofs, see page 74.

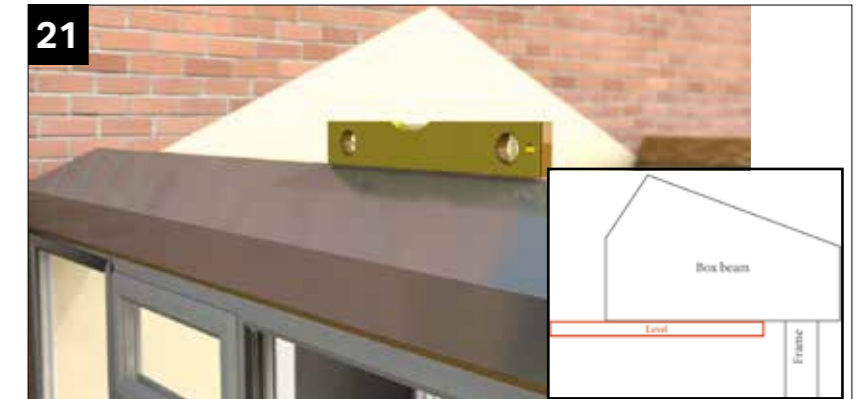

Check all is level - pack off top of frames if necessary. **CHECK THE UNDERSIDE OF THE BOX BEAM IS LEVEL PRIOR TO FINAL FIXING. PROP IF NECESSARY.**

THE SETTING OF THE BOX BEAMS IN KEY TO A SUCCESSFUL INSTALLATION. ONCE SET SILICONE SEAL THE UNDERSIDE OF THE BOX BEAM TO THE HEAD OF THE FRAMES INSIDE AND OUT.



If packers used, recheck for being square, also check diagonals (corner to corner measurement). When these checks are complete finally secure by screwing up through head of frames into box beam. Fixings need to be within 200mm of each corner and at 450mm centres using, for example 4.8 x 80mm baypole screw NOT PROVIDED.



Remove timber positioning dowels (see step 3b). Fix up through the front 90° beam support shelves into the box beam using 6x5.0 x 50mm countersunk wood screw (RRX 025) provided. See fixing points at 23b (standard soffit) and 23c (extended soffit).

RRX 025
5.0 x 50
C'SNK pozi
heco fix wood
screw.
[6 fixings
each]

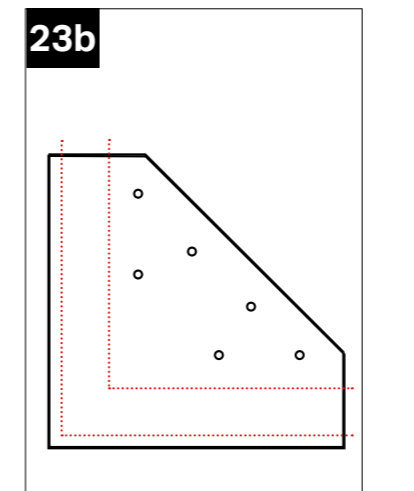

Fixing positions for standard soffit.

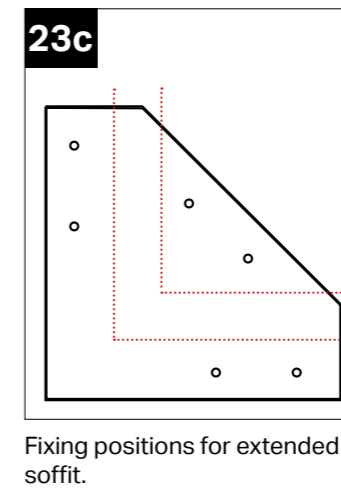

Fixing positions for extended soffit.



Fix up through the rear box beam wall brackets into the box beam using 6 x 50 x 50mm countersunk wood screws (RRX 025) provided. Finally ensure all box beam joints are fully sealed inside and out.

GEORGIAN INSTALLATION - SOLID ROOF - STRUCTURAL FRAMEWORK



With the box beam secured assemble the 2 part ridge support starter bar extrusions using the single fixing provided.

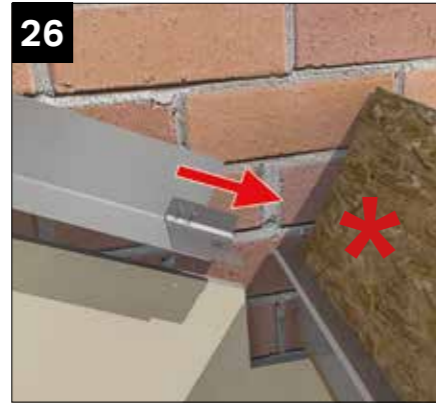

* Remove 10mm spacer (attached to beam face). Once assembled lift and position against the host wall. Slot onto beam support shelf.



Place angle finder under starter bar to check the pitch. Fix aluminium starter bar extrusions to the host wall (pack off where needed) within 200mm of ridge and box beam plus at least one more equidistant between the two. Use resin anchors suitable for substrate (NOT PROVIDED).

IMPORTANT
PLEASE READ IF YOUR ROOF FEATURES GLAZING AT THE HOST WALL, SEE PAGE 33.

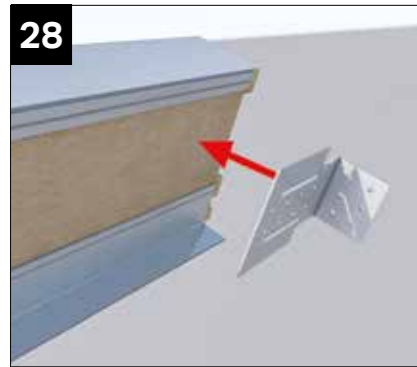

To the rear of the ridge, offer the adjustable rear fixing bracket (one each side) into position.



Attach via the slots using 2 x NRTF050 4.2 x 25 wafer head self drilling screws provided. Do not fully tighten at this stage.

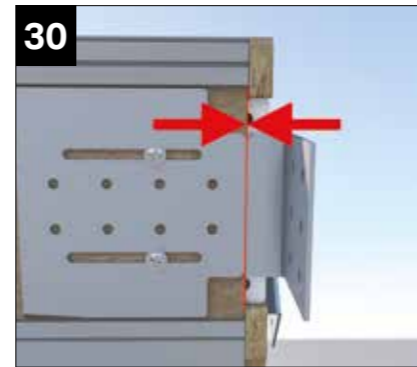

Slide the bracket so that the 'V' notches align with the aluminium ridge section extrusions then tighten screws.



Offer the ridge into position. **IMPORTANT: Support the ridge with adjustable support props. The props must stop in place until the roof is fully built.** Check for being level.

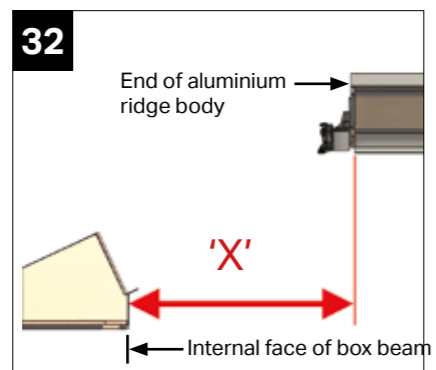

To set the ridge check critical dimension job sheet for dimension 'X'.

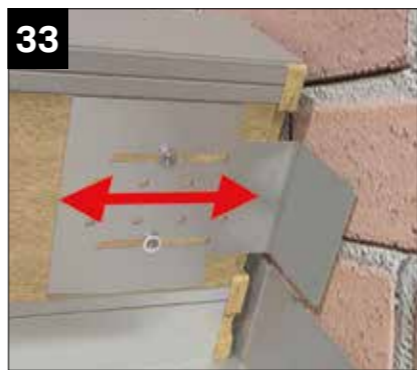

The bracket allows for the ridge to be adjusted to meet dimension 'X'.

GEORGIAN INSTALLATION - SOLID ROOF - STRUCTURAL FRAMEWORK \ PANEL SEQUENCE



Once ridge is set and level, secure to the host wall using resin anchors suitable for substrate (NOT PROVIDED).



Finally secure the rear ridge fixing bracket using 8 x NRTF050 (PROVIDED) one bracket on each side of the ridge.

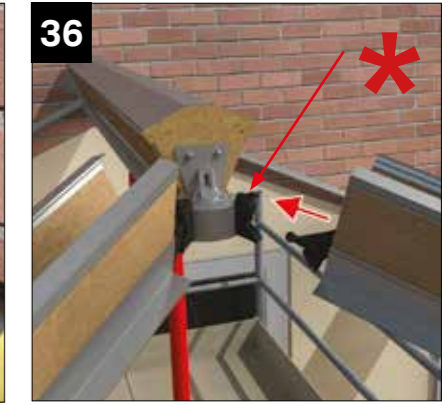

Offer into position the hip bars. Using the speedlock on the glazing bar end offer the 'ball' into the mating speedlock housing attached to the ridge end.

* Tap down upper dead lock. Push up lower wedge lock see step 40.



The Ultrarof hip design has been updated; extending the steel and aluminium components over the beam mitre for an improved structural connection. See page 74 for hips with variable pitches.



When in position (tight to the corner) the hip should sit on the box beam shelves.



Fix the hip down into the box beam through 4 x pre-drilled holes using WPCS020 screws (provided). **NOTE: The external box beam cleat is still required.**

PANEL FITTING SEQUENCE

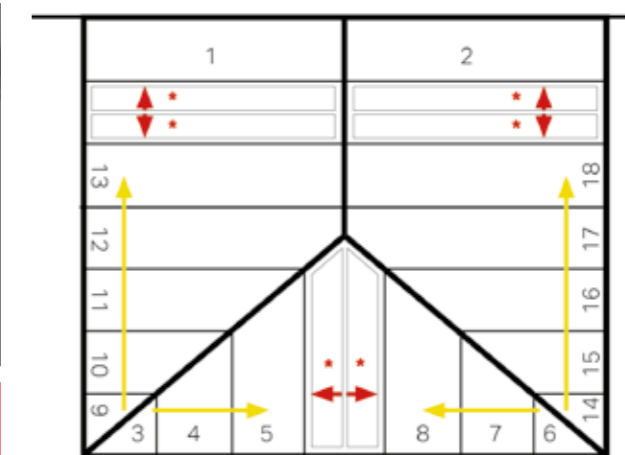

Do not snip panel straps until all panels are fully installed



NOTE:
IF GLAZING IN ROOF FIT SHOES TO BEAM AND RIDGE, FIT GLAZING BARS SEE PAGE 41.
PRIOR TO FITTING PANELS!

Now lower into position the 2 host wall panels 1&2, one either side of the ridge. Then panels labelled yellow.

* = ALL RED EXPANDABLE PANELS EXPAND OUTWARDS AND ARE INSTALLED LAST

GEORGIAN INSTALLATION - SOLID ROOF
- STRUCTURAL FRAMEWORK



Next, install Ultrapanel working from each hip bar towards the centre.



Lower into position the front facet panel. Marked with a red label.



The expandable panel will expand to take up any tolerance gap. Snip the binding cord on all the remaining front facet panels.

Do not cut the binding cords.



Repeat the process on the side facets.



Finally lower into position the expandable panel. Marked with a red label.

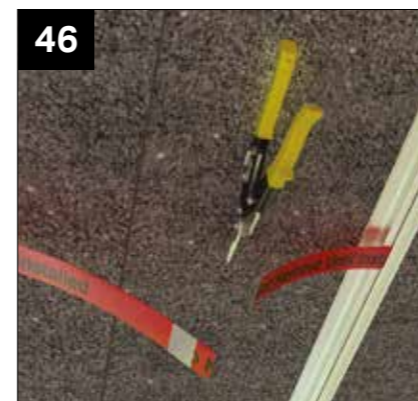

When in position snip the retaining straps.



When all panels installed continue to fit the pre drilled external panel clips (see next image for positioning alignment)

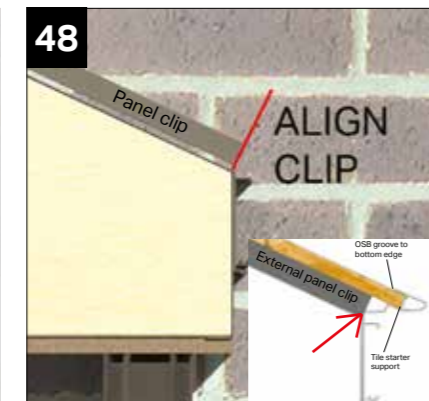

Ensure the panel clip butts up to and inline with the aluminium gutter channel extrusion prior to knocking down. **This is important to ensure correct positioning of tile starter support.** (See larger image at step 52, page 25).

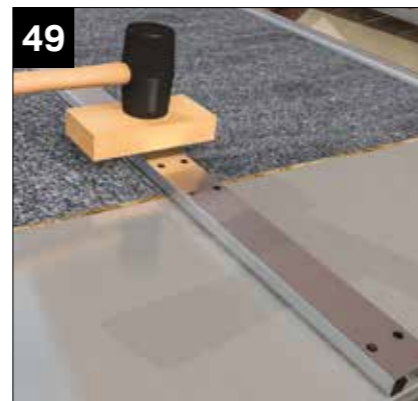

When aligned use a robust mallet to knock down the external panel locking clips (use a short length of timber to protect the clip from indentations).

GEORGIAN INSTALLATION - SOLID ROOF
- STRUCTURAL FRAMEWORK

NOTE: PRINTED SIDE OF OSB BOARD FITTED FACE DOWN (ROUGH FACE)



Finally secure the external clips using WPCS020 4.8mm x 38mm self drilling screws provided. (2 into ridge section, 4 into panels and 4 into box beam on full length clips) or through pre-drilled holes on short clips or half clips.



Fit tile starter support, silicone + push fit.

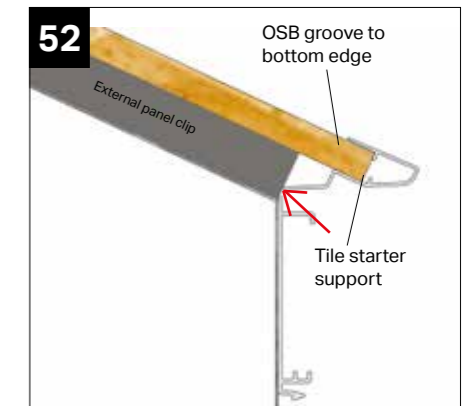

Using location plan, lift OSB board panel A into approximate position. Having fixed tile starter support onto end of OSB, place against ends of external panel clips to locate OSB. Locate first row of OSB panels around the roof using tile starter support to position. Work in the same order that the beams were put on (sides toward front).

ON THE MITRED CORNERS OF THE BOX BEAM THERE WILL BE A 30MM GAP BETWEEN THE SHEETS OF OSB. TIP: USE A 30MM TIMBER BLOCK TO CHECK THE CORRECT SPACING OF THE OSB BOARD.

AS STEP 53, SUPPORT ANY FLOATING OSB BOARDING WHEN DISTANCE EXCEEDS 600MM TO EXTERNAL HIP USING TIMBER BATTENS PROVIDED.



Where required support OSB board at butt joints using timber battens supplied. Battens are 65 x 19 x 700mm long (NRPB010). Only required over box beam using the screws provide WPCS 020 (2 x per batten).



Following location plan, locate first row of OSB panels around the roof using tile starter support section to position. Ensure OSB sheets are the right way up, orientation.



With OSB in position fix board 70mm up from tile starter support and 70mm down from upper edge followed by 1 x central fixing. NOTE: Fixing position at step 56.

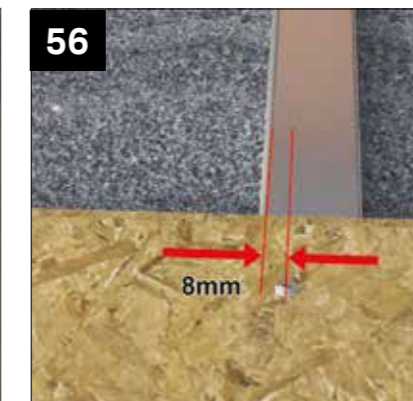

All boards to be secured 8mm in from either edge. 3 fixings per clip position using NRPS050 4mm x 25mm screws, provided.

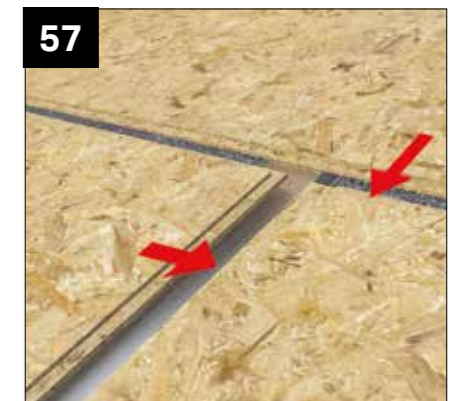

All OSB board edges are tongue and grooved to allow positive location. Continue to board from bottom to top (box beam to wall plate).

GEORGIAN INSTALLATION - SOLID ROOF
- STRUCTURAL FRAMEWORK

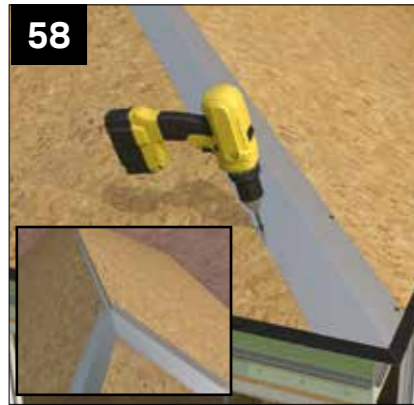

58
Fit steel hip plates inline with upper edge of the tile starter support strip. [Fixings 300 centres through predrilled holes using NRTS050].
NOTE: THESE ARE SUPPLIED IN TWO HALVES IF OVER 3.2M IN LENGTH TO ALLOW FOR ADJUSTMENT / OVERLAP IF REQUIRED.

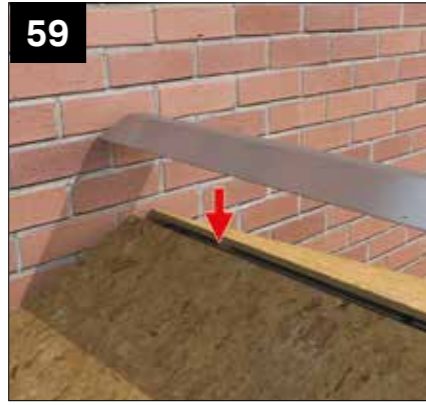

59
Place aluminium ridge cover plate 10mm away from host wall. Fix through the predrilled holes using 4.2 x 25 wafer head drilling screws (NRTS 050) provided.
Installing the breathable membrane at this point will ensure weather tightness.

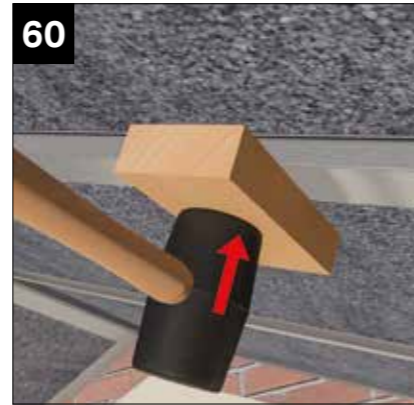

60
Now offer into position the pre drilled internal panel clips. Again, use a timber packer to prevent indentations to the internal clip. NOTE: short lengths, tap into position. Longer lengths, follow sequence steps 63-65.



61
Firstly secure into the panel (at the ridge end) using dry wall fixing screws WPDS020 **NOTE: See method of alternate tightening as shown 63-65.**



62
Secure into the panel (at box beam end) as previous image. **Again, note method of alternate tightening sequence 63-65.**

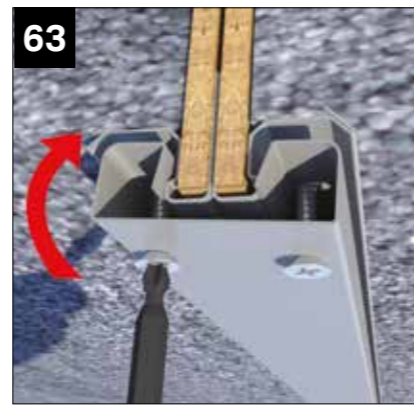

63
Loosely tighten alternative screws to enable easy clamping of internal caps.

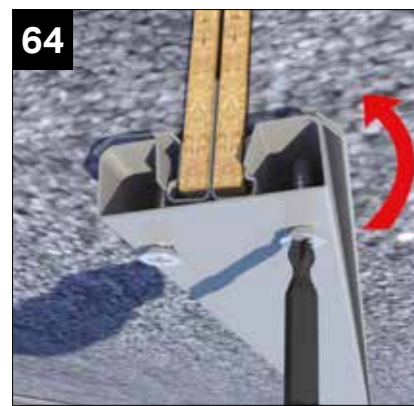

64
One side then the other.

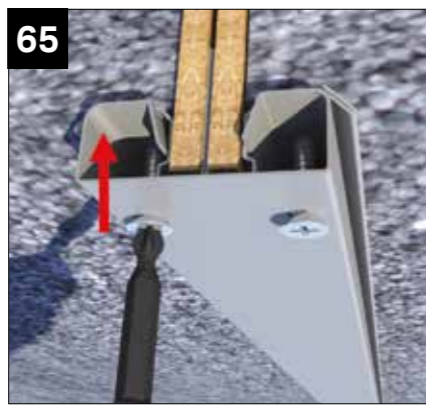

65
Fully clipped into position. NOTE: for longer lengths you may need to tap on as step 60 above.



66
Secure attachment plate using 2 x CHAA 006 screws provided to box beam support shelf.

GEORGIAN INSTALLATION - SOLID ROOF
- STRUCTURAL FRAMEWORK



67
Secure attachment plate using 2 x CHAA 006 screws provided to the ridge body.



68
Where jack rafter abuts hip bar fix the jack rafter connection plates using 4 x CHAA 006 screws provided. NOTE: fit one screw through half clip that meets hip bar.



69
Fix the internal hip retaining plates using 18 x CHAA 006 screws provided into the box beam shelf and hip bar. **NOTE: These plates are not required on victorian hips.**

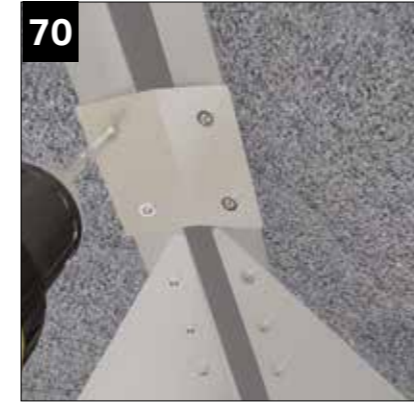

70
Fix the internal lower hip brace plate using 4 x CHAA 006 screws provided.



71
Fix the internal upper hip brace plate using 4 x CHAA 006 screws provided.



72
Image shows roof covered with breathable membrane. Follow the sequence. Membrane part no: RRMA050

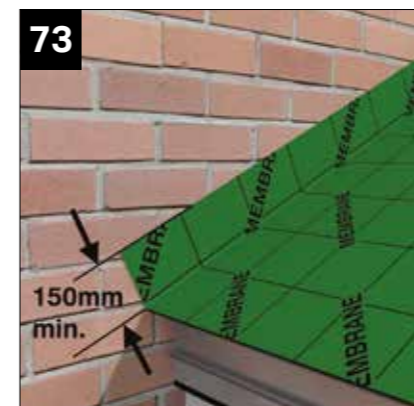

73
Start at eaves and position 150mm up the host wall. Place membrane (as step 75). Overlap each hip (as step 76).

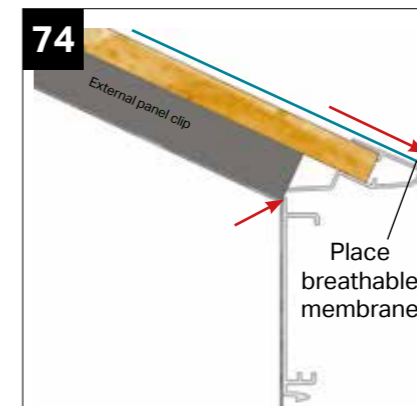

74
The breathable membrane is aligned to the front edge of the tile starter support.

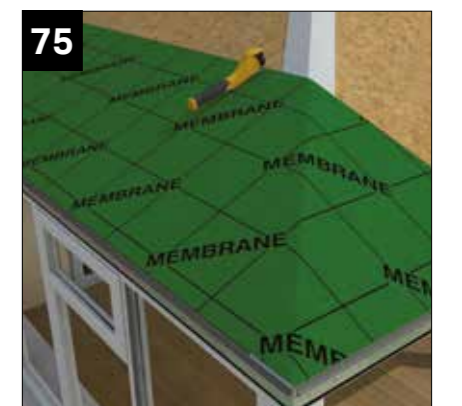

75
Minimum 200mm overlap over hips. Fix using staple hammer with maximum 12mm stainless steel staples. Take care not to cut through lower layers whilst trimming.

GEORGIAN INSTALLATION - SOLID ROOF - WATER PROOF UNDER LAYER

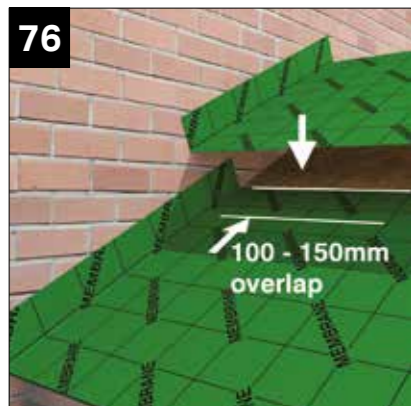

Work up the roof, overlapping the previous layer by 150mm at pitches of 14° or below and 100mm at 15° and above.



On solid roof, the membrane layer straddles the ridge. Slit as shown to allow transition to the opposite side. If the membrane falls short of the ridge plate, install an additional canopy, centrally over the ridge.

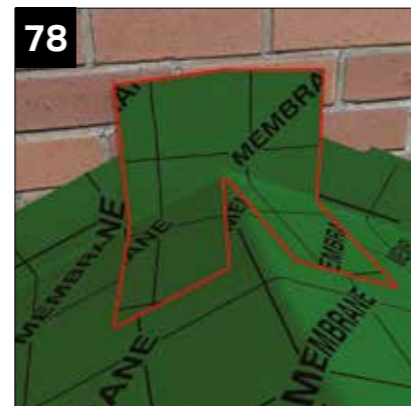

Install additional patch of membrane to protect the apex at the host wall. Secure with tape supplied.



Patch fully taped.

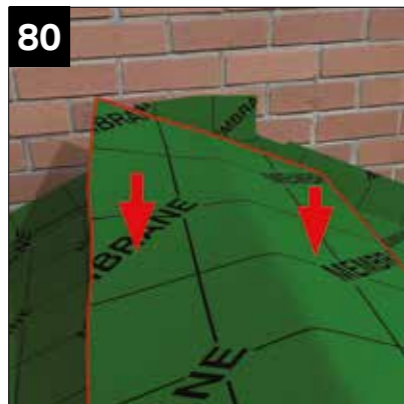

Finally cover the previously installed patch with a third layer to ensure positive seal. Staple into position.

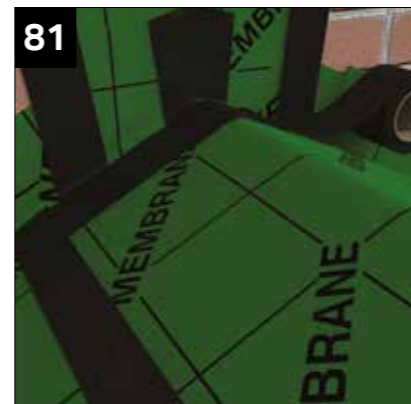

Use tape to seal the layer at ridge end.



Find the centre line of the steel hip capping plate below the membrane and mark a centre line through to the final point.



Place the hip spine with the centre aligned to the final point, mark each side of the spine then remove.



With the spine removed. Continue to follow fitting of the tile starter strips.

GEORGIAN INSTALLATION - SOLID ROOF - HIP SPINES / ULTRATILE

READ BEFORE FITTING

FAILURE TO FOLLOW THESE INSTRUCTIONS CAN RESULT IN TEMPORARY DISTORTION WHICH MAY MEAN TILES WILL NEED TO BE RE-LAID. Following these instructions allows tiles to correctly 'float' for expansion and contraction.

1. ENSURE TILES ARE FITTED TO THE CORRECT INSERTION LINE – **DO NOT PUSH TILES TOGETHER.** Insertion lines vary according to temperature when installed
2. **DO NOT OVERTIGHTEN SCREWS**

The NRTT001 Tile Screw Fixing Tool can be found with the NRTF050 screws inside the fixings component box.

Hold the tool in place as shown whilst installing each screw and remove to ensure a fit which is close but not too tight – This is to allow for the expansion and contraction of the tiles.

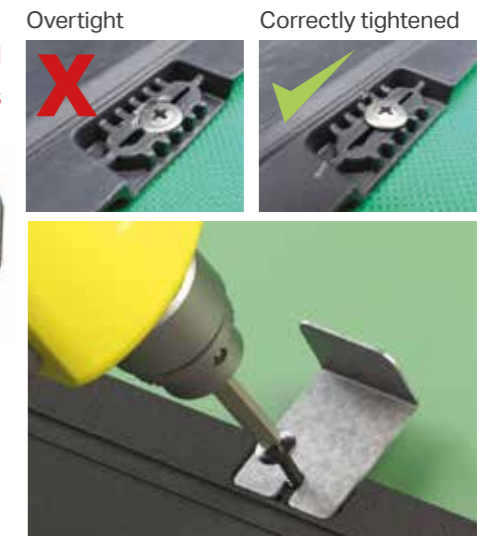

Tile starter strips are lettered in correspondence with its location shown in the tile location plan. **TILE STARTER STRIPS ARE NOT FITTED IN ALPHABETICAL ORDER, PLEASE FOLLOW INSTALLATION SEQUENCE ON THIS PAGE FOR CORRECT FIT.**

GLAZED ROOF

Details shown also apply to Victorian shapes.

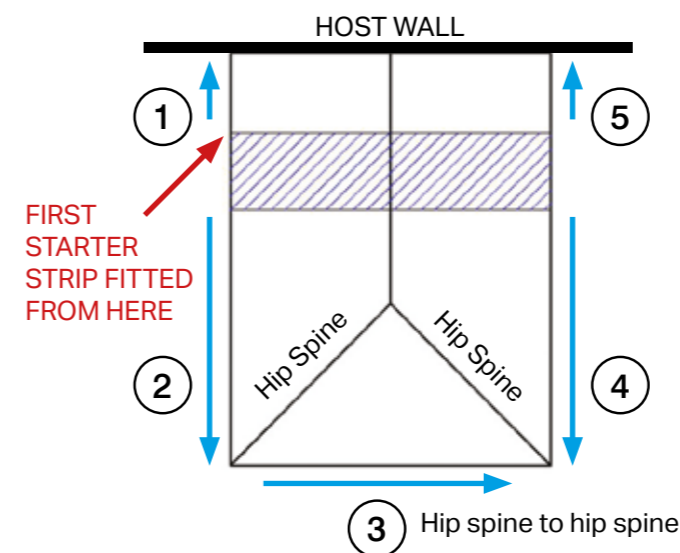

If a roof contains rectangular glazing panels, starter strips must be set out from the glazing bar centre.

KEY
Fitting order is labelled ① to ⑤
Direction of starter strip fitting →

SOLID ROOF

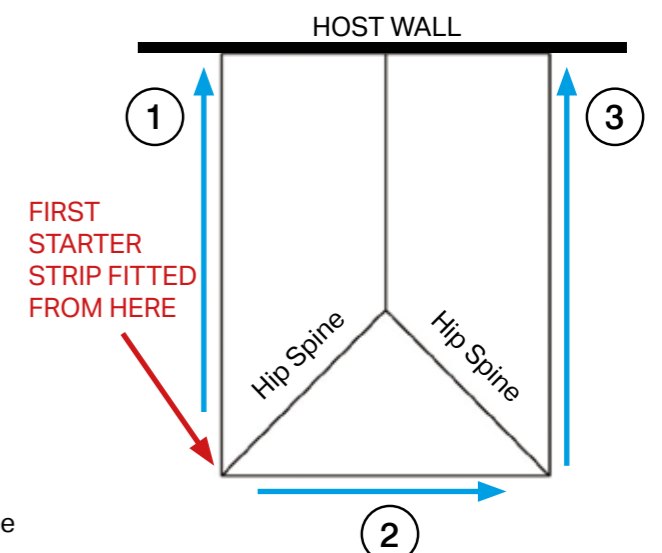

If a roof contains no rectangular glass panels and is classed as 'solid' then starter strips must be set out from the hip spine.

KEY
Fitting order is labelled ① to ③
Direction of starter strip fitting →

GEORGIAN INSTALLATION - SOLID ROOF - HIP SPINES / ULTRATILE

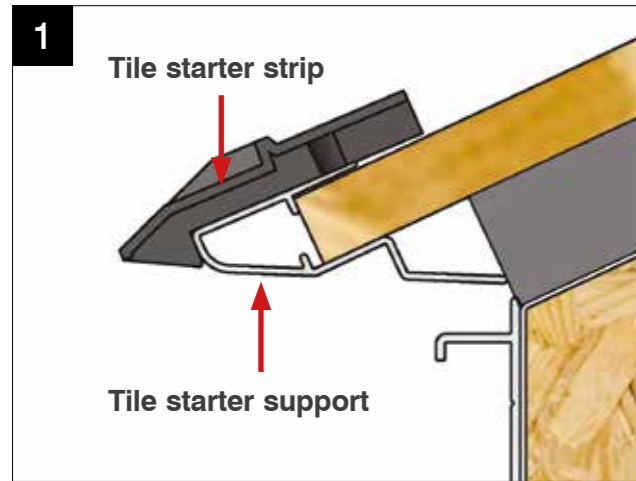

Place starter tile strip on starter tile support, make sure strip is a tight fit up against support.

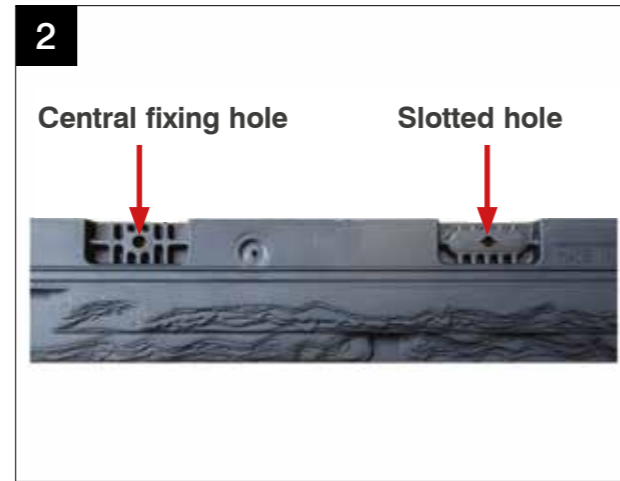

Fix through the central fixing hole for temporary fitting. **(DO NOT FIX THROUGH SLOTTED HOLES UNTIL ALL STARTER STRIPS ARE IN PLACE)**

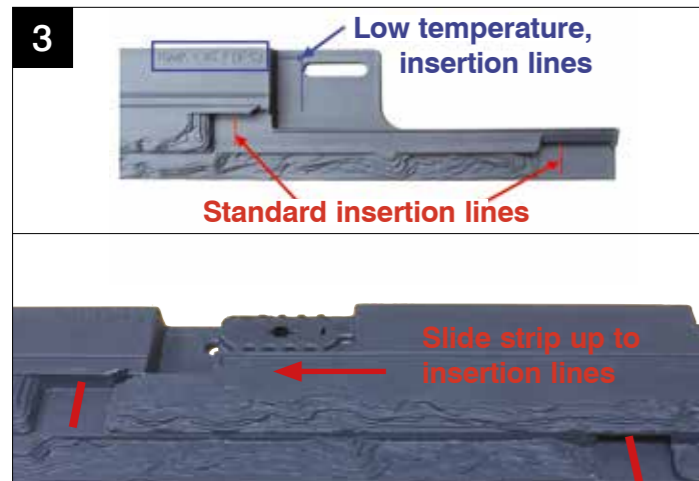

Following the direction stated in the fitting guide (see p29). Align next starter tile strip with the standard insertion lines. **NOTE: IF AIR TEMPERATURE IS BELOW 5°C, ALIGN WITH THE LOW TEMPERATURE LOCATION MARK (TOP RIGHT OF STRIP)**

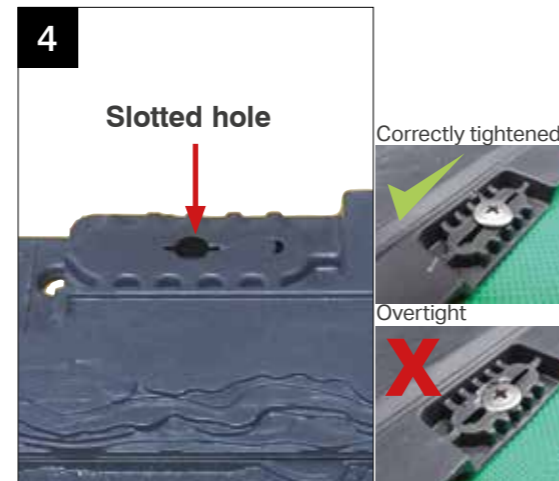

Repeat steps 3&4 following the fitting order guide until all starter strips are in place and are correctly fitted. Once correct, fully fix through slotted holes along the starter strips for permanent fix.



This image shows the starter tile strips being fitted to the already marked hip spine lines (the hip spine will have been removed, see steps 83-84, page 28).

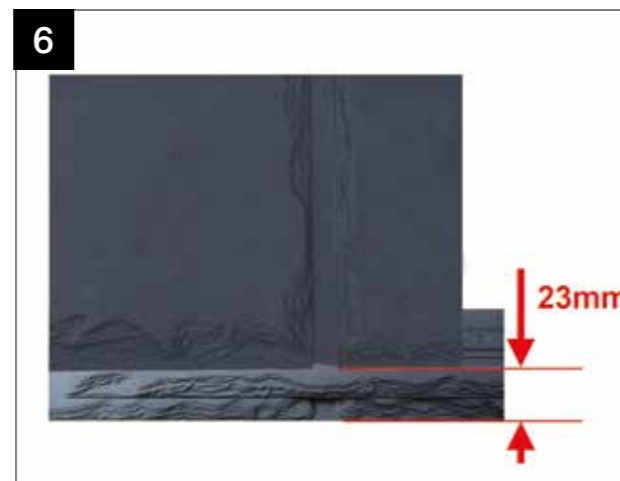

Using the tile location plan provided, locate position of first tile panel (labelled aa1), slide down onto the starter strip leaving 23mm from the starter strip edge. This allows expansion of the tiles in warm temperatures.

GEORGIAN INSTALLATION - SOLID ROOF - HIP SPINES / ULTRATILE

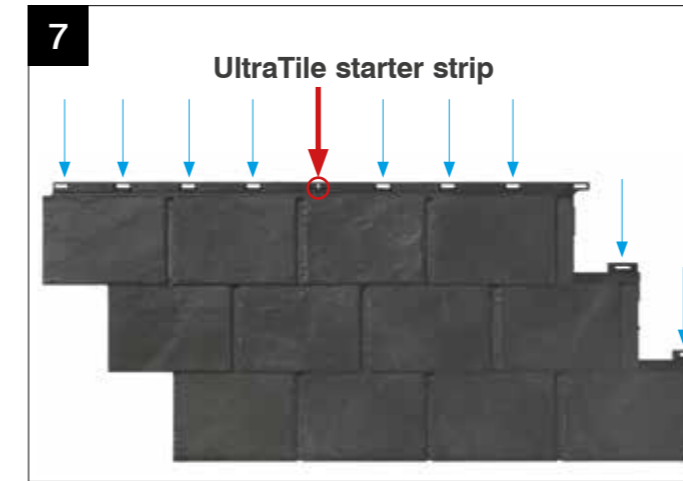

STEP 1 – fix through central non adjustable fixing hole
STEP 2 – fix through remaining slotted holes (10 holes)

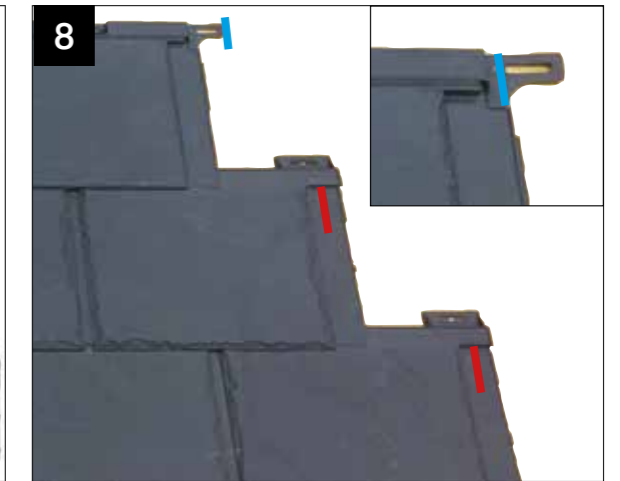

At normal temperatures, of around 15°C, use the insertion lines indicated red in the image. For low temperature installations, below 5°C, use the single insertion line indicated blue, at the top right of the tile.

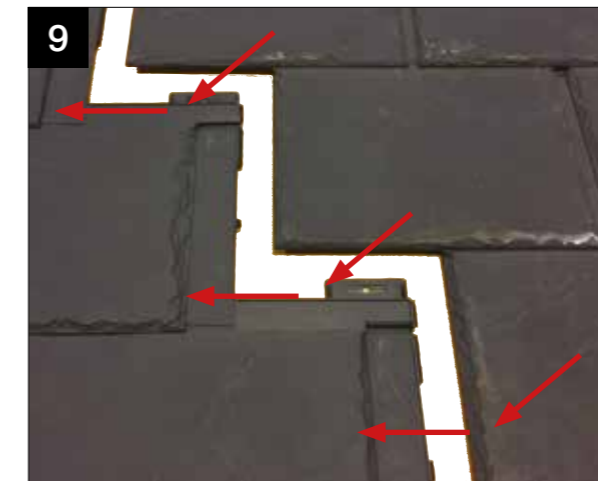

To slot the tiles together, a down and left action is used in one movement. Make sure all tabs have interlocked. Tiles are fitted to the roof from left to right bottom to top. Repeat steps 7,8 and 9 for entire layer.

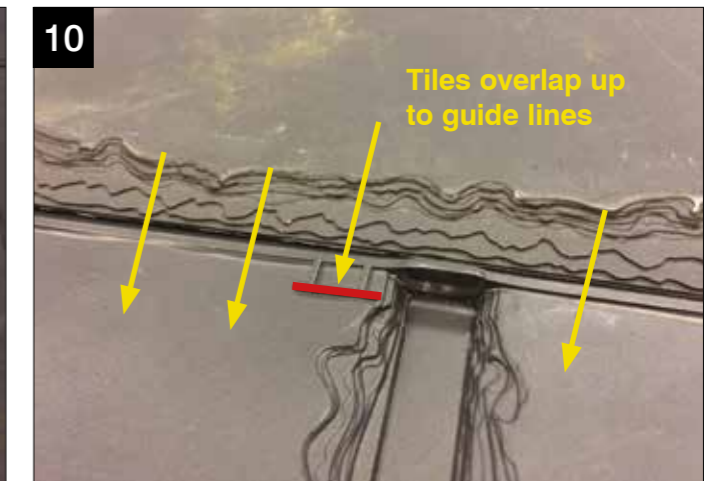

When inserting next layer, overlay tiles in line with insertion lines (marked in red above) on the tile. Repeat steps 8, 9 and 10 until the roof is fully tiled. See tile finishing references on back for accurate fit and best results.

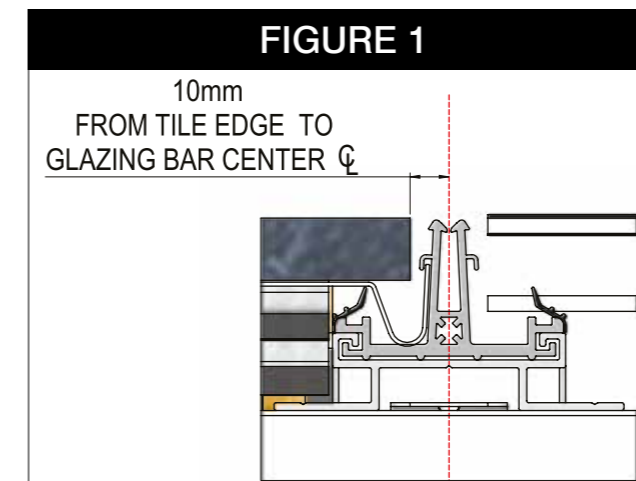

If the roof contains full rectangular glass panels, the starter strips **MUST** be fitted from the glazing bar.

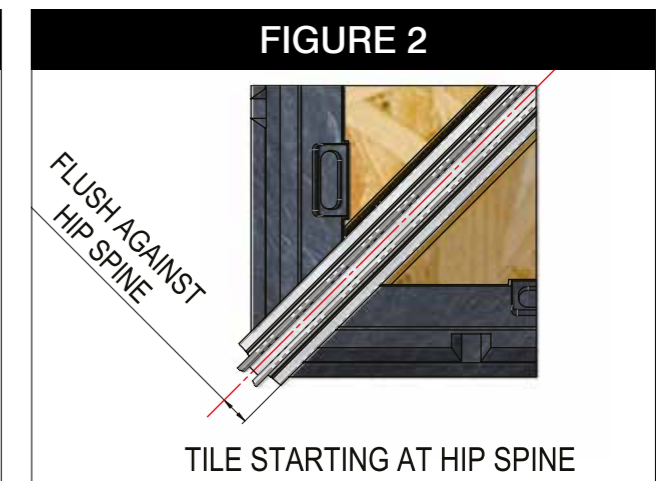

If the roof contains no rectangular glass panels, then the starter strips **MUST** be fitted at the hip spines first.

INSTALLATION - TILE FINISHING REFERENCES



Distance from bottom tile edge to tile overlap insertion lines.

This is the amount of tile that should be visible on each layer of the roof. This is a good check to see if the tiles are in the correct position with correct spacing allowances for heat expansion.

REFERENCE DIMENSIONS ONLY - NOT SET OUT DIMENSIONS
- site conditions may cause these dimensions to vary.

INSTALLATION - TILE FINISHING REFERENCES

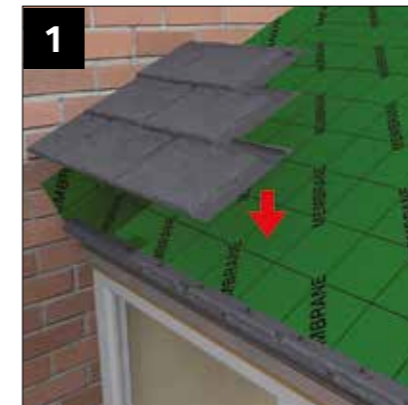

Using the tile location plan provided, locate position of first tile panel (labelled aa1), slide down onto the starter strip leaving 23mm from starter strip edge (page 30 step 6). This allows expansion of the tiles in warm temperatures.



Continue tiling the roof as above, working anti-clockwise around the roof. Each set of tiles are pushed down, then slid to the left to engage.



Fully tiled roof. Ensure the 30mm spacing is maintained between tiles on adjacent facets to accommodate the hip spine. Fit the hip spine on completion of the tiling.

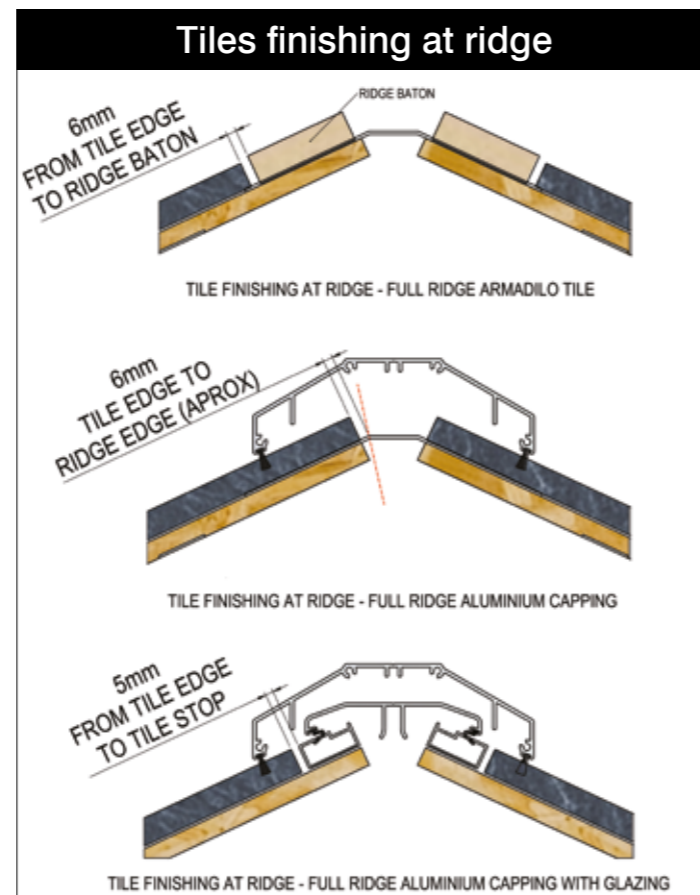
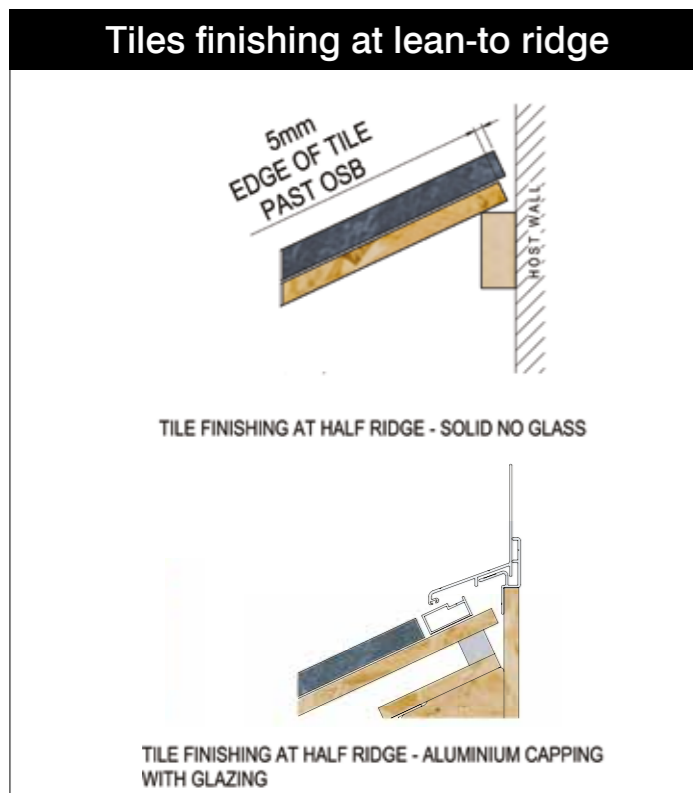
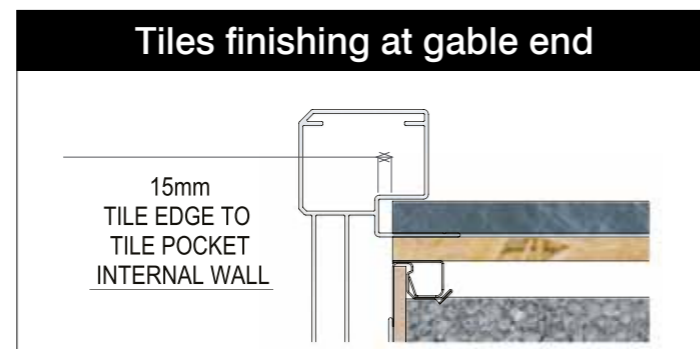
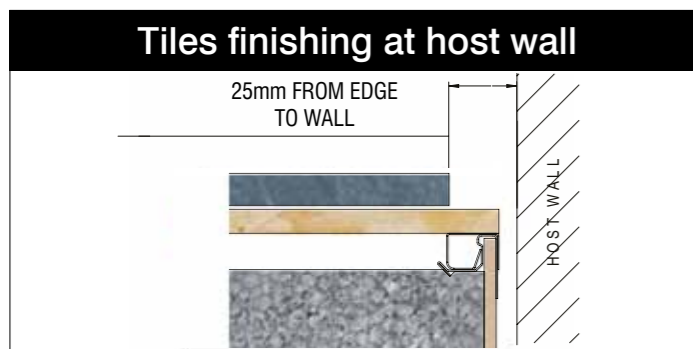

FOR MORE DETAILED INSTALL OF TILES, PLEASE READ THE FULL INSTALL GUIDE FOR ULTRAROOF



Once tiled, re-fit the hip spine. The hip spine is set 10mm out beyond the mitred lower hip point. Secure the spine at 500mm centres using 4.2 x 25 wafer head self drilling screws (NRTS050) provided.

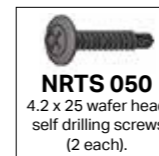

IMPORTANT

IF TILES ARE REPLACED OR RE-POSITIONED SEAL ANY HOLES LEFT BY REDUNDANT SCREW POSITIONS.

IF MANY TILES ARE REPLACED IT WILL BE NECESSARY TO REPLACE THE MEMBRANE.

IMPORTANT - Please read if your roof features glazing at the host wall



Once ridge is set and level, drill through brackets into host wall, THEN REMOVE SETOUT COMPONENTS.



Reposition ridge and secure to the host wall using resin anchors suitable for substrate (NOT PROVIDED).



Finally secure the rear ridge fixing bracket using 8xNRTF050 (PROVIDED) one bracket on each side of the ridge.

GEORGIAN INSTALLATION - SOLID ROOF - CAPPINGS



1 Pre-drill ridge cap at max 750 centres, 6mm holes.



NRRSA 005BL 5.5 x 90mm hex washer head self drilling tek screw (with G16 stainless steel sealing washer)



2 Dry fit the ridge cap with radius end cover and position radius end flashing to create a consistent apron off set. Mark the position before removing the ridge cap. Peel off the self adhesive backing (grey only). Mould and adhere in position on top of the tiles as shown (no adhesive required for red and brown flashings).

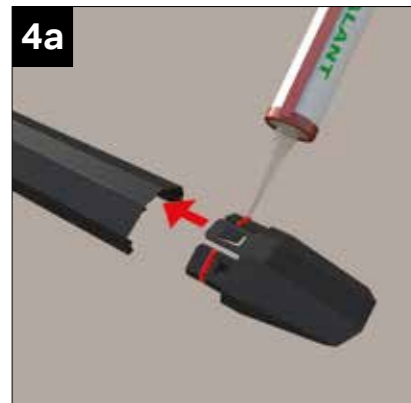

3 Centralise ridge top cap over apex. Position 5mm away from host wall. Foam fill void, prior to dress leading. Fix ridge top capping using 5.5mm x 90mm (NRRSA 005BL) provided.



4a The hip bar top cappings at the radius end require (LMEC004) fitting, these require a bead of silicone applying prior to push fitting onto the end of each bar.



4b Clip fit hip capping, ensure fixing clips are set at 500 centres (pre - fitted clips).



4c Position hip bar top cappings as shown. Ensure the lower end of the capping is inline with the hip spine prior to fitting end cap.



5 Fit hip spine end caps. NOTE: (NRES 004) end cap fixing screw comes complete with 2 part coloured screw cap cover.

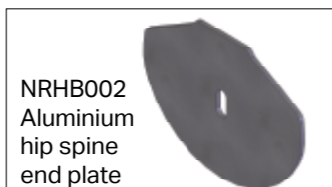

6 If using existing flashing, dress down over the roof and ridge area then finish as normal. Flashing may need trimming to fit neatly. Apply patination oil to lead for peace of mind (Avoids unsightly lead sulphate run off). Alternatively install new code 4 lead.

GEORGIAN INSTALLATION - SOLID ROOF - FASCIA SOFFIT AND GUTTERING



7 Screw fix PVCu soffit channel into head of window frame or base of OSB board (screws not provided).

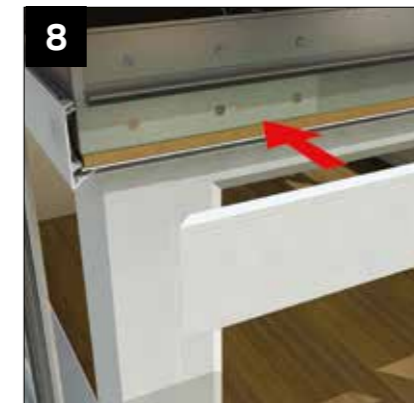

8 Clip fit PVCu fascia board locating upper leg to lower leg of aluminium gutter channel (see cross section detail on page 11).



9 Fit PVCu fascia corners with silicone.



10 Fit gutter bracket by placing lower leg onto aluminium gutter channel then 'snap back' upper leg. Space at maximum 750mm centres and within 200mm of corner.



11 Fit Marley Classic guttering. Ensure when fitting the gutter you fit to the insertion marked lines within the unions / gutter corners.

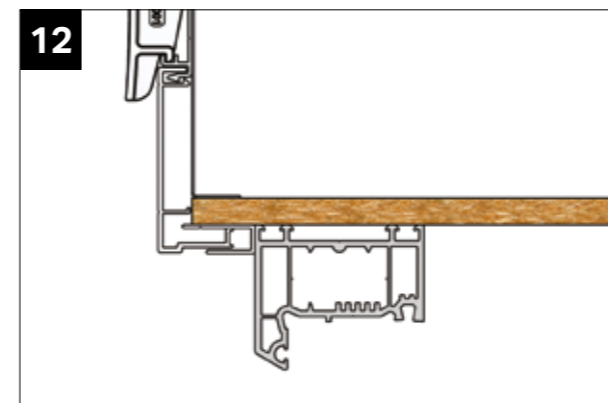

12 Standard soffit in detail. Silicone seal 'U' channel to retain lower edge of fascia.

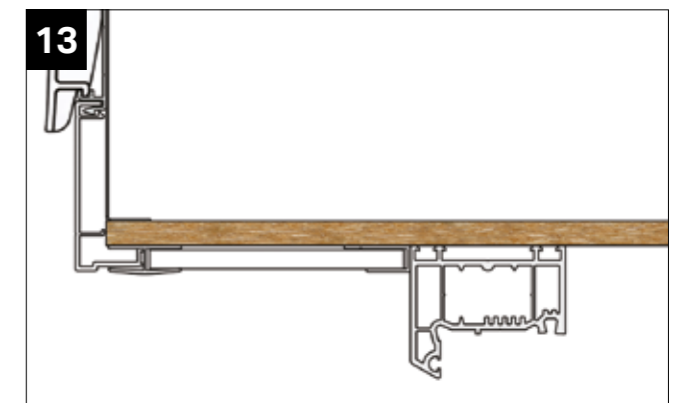

13 Extended soffit in detail (must be used above super-insulated columns). Silicone seal to retain fascia into 'H' section and soffit into 'U' channel.

DOWN LIGHT INSTALLATION

THE ULTRAROOF BEAM IS NOW INSULATED WITH MINERAL WOOL

This guide shows our recommendations when installing internal down lights in the Ultrarroof beam. All electrical work must be carried out by a qualified electrician and tested in accordance with current BS7671 IEE wiring. **Downlighters must be LED IC (insulation contact) Fire Rated.**

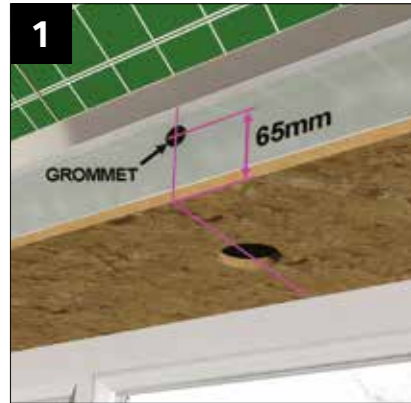

1 Cut a hole in the base of the pelmet for your light fitting. Cut a corresponding 20mm dia. hole in the vertical face and fit a rubber grommet.

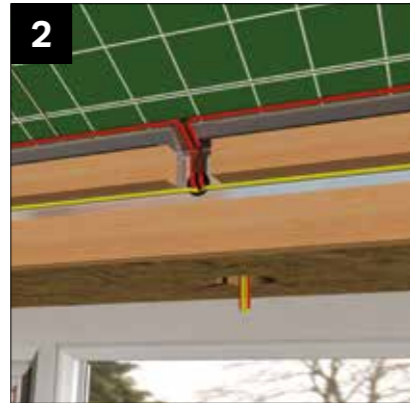

2 The cables can be passed through the grommet and chased above or between the internal battens as shown. Internally, the wiring should be passed beneath the mineral wool insulation (see inset diagram).



3 At lower pitches, when only one batten is fitted, the hole (and grommet) are positioned lower on the vertical face and the batten split to allow cable access.



4 At pitches lower than 17 degrees there is insufficient space on the vertical face to fit the 20mm grommet. Drill 2 holes either side of the light fitting to allow installation of the wires as shown. A 'channel' can be created using 2 narrow strips of plasterboard covered with a top panel.

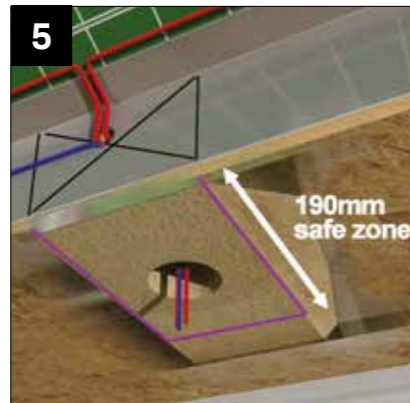

5 If the light is coincident with one of the internal foam fillets (defined by the marking on the vertical face) it must be positioned in the 190mm safe zone.

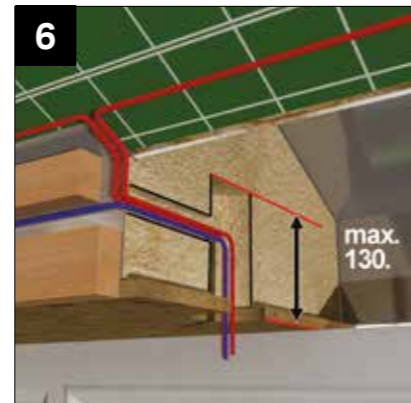

6 Drill through the OSB and vertical face creating the wiring access. The size of the fitting may require additional space.

NOTE: The cavity should not exceed 130mm from the underside of the beam face

THE ULTRAROOF BEAM IS NOW INSULATED WITH MINERAL WOOL

PRIOR TO PLASTERBOARDING (TO ACHIEVE 0.13 U-VALUE)

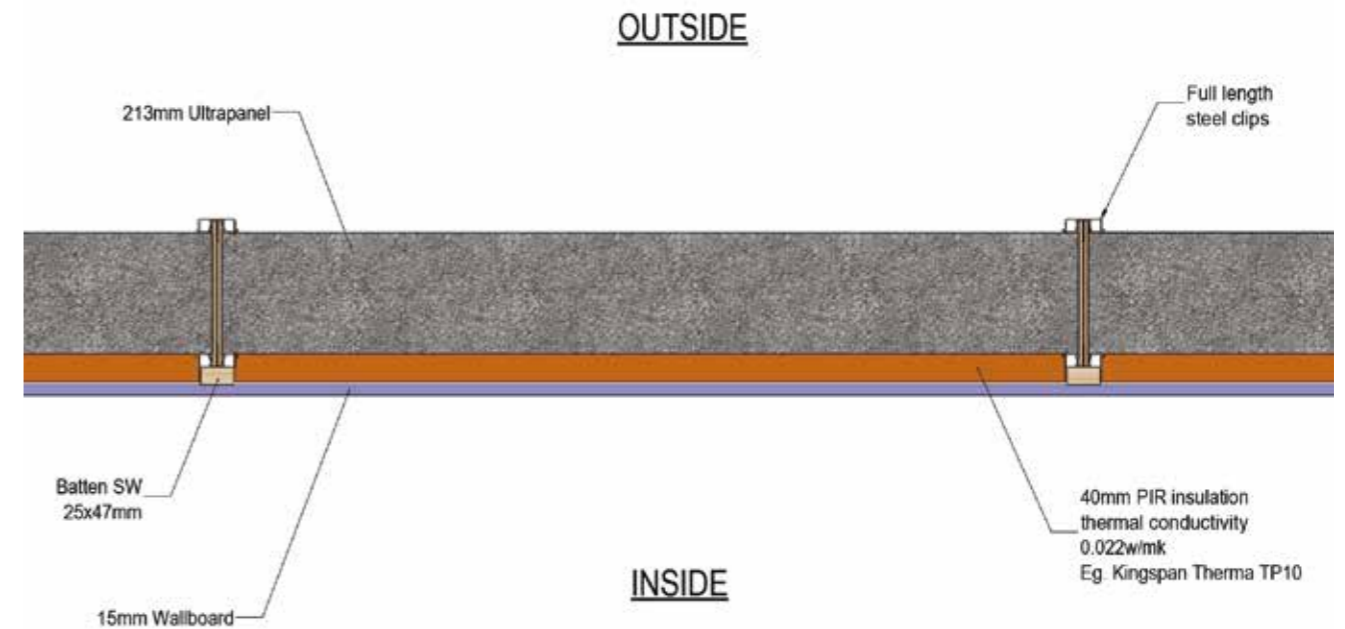

OVERALL U-VALUE 0.13W/M2K

PLASTERBOARD GUIDELINES



Dry wall bit assembly

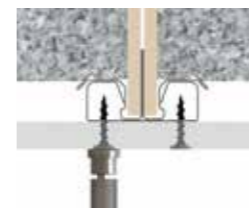

Full Clip Section

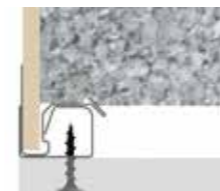

Half Clip Section

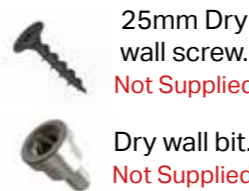

25mm Dry wall screw. **Not Supplied**

Dry wall bit. **Not Supplied**

We recommend plaster boarding vertically, attaching the plaster board directly to the internal panel clips.

Horizontal butt joints need supporting with a 20mm thick timber batten (not provided) placed between the internal panel clips.

A bead of silicone will hold the batten into position before securing.

Fixing of the plaster board is the responsibility of the plastering team in line with manufacturing recommendations.

Solid Roof

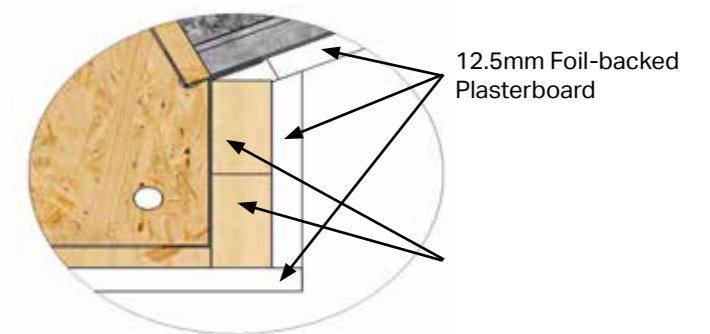

NOTE: Please see page 74 for roofs with variable pitch.

PLASTERBOARD GUIDELINES

Glazed Roof

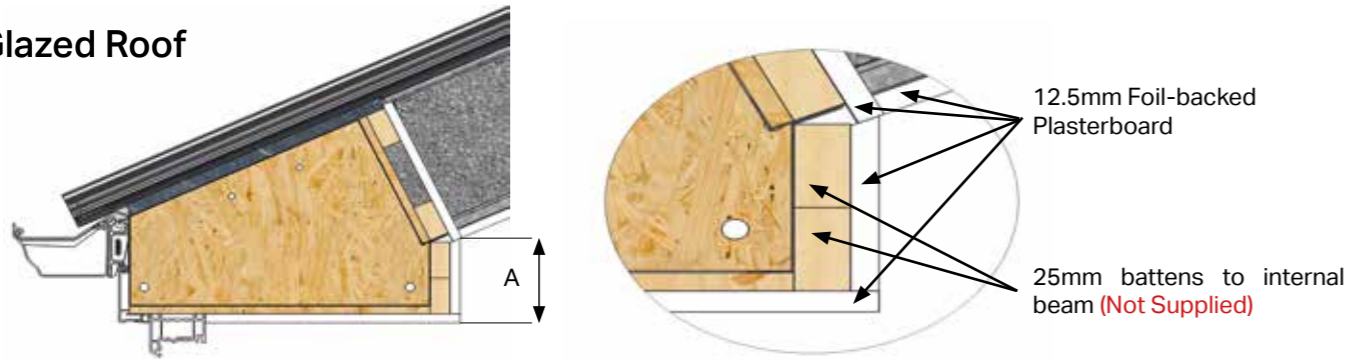

Internal Pelmet Height Calculator

Pitch	15	20	25	30	35	40
'A' Solid Roof	25	59	92	127	163	202
'A' Glazed Roof	29	63	98	134	172	212

Eaves Glazed Zone

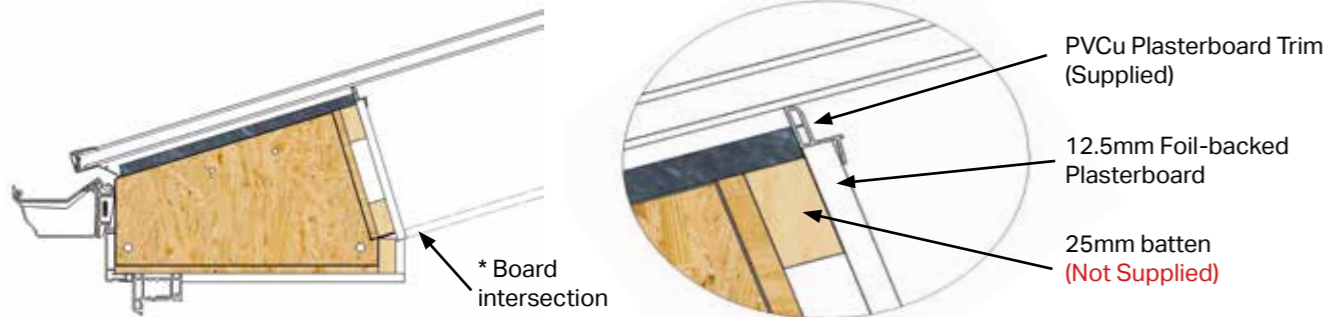

Ridge Glazed Zone

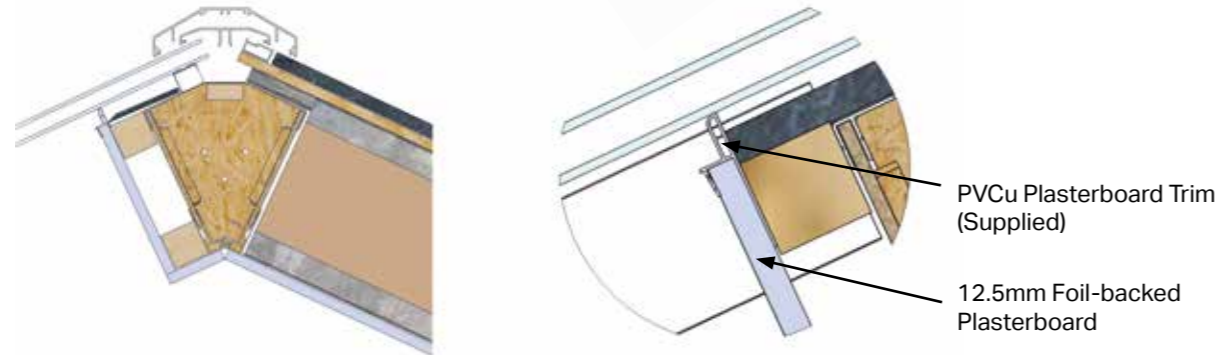

Lean-to at 12.5 Degrees

Solid Roof

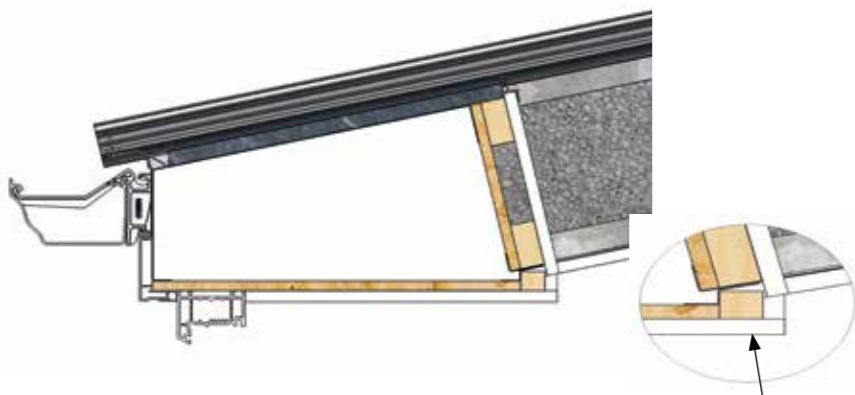

Glazed Roof

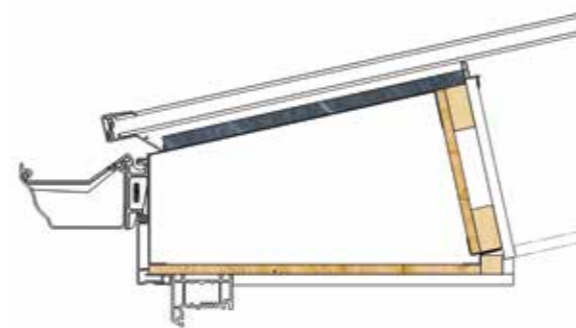

PLASTERBOARD GUIDELINES

Variations on Brickwork

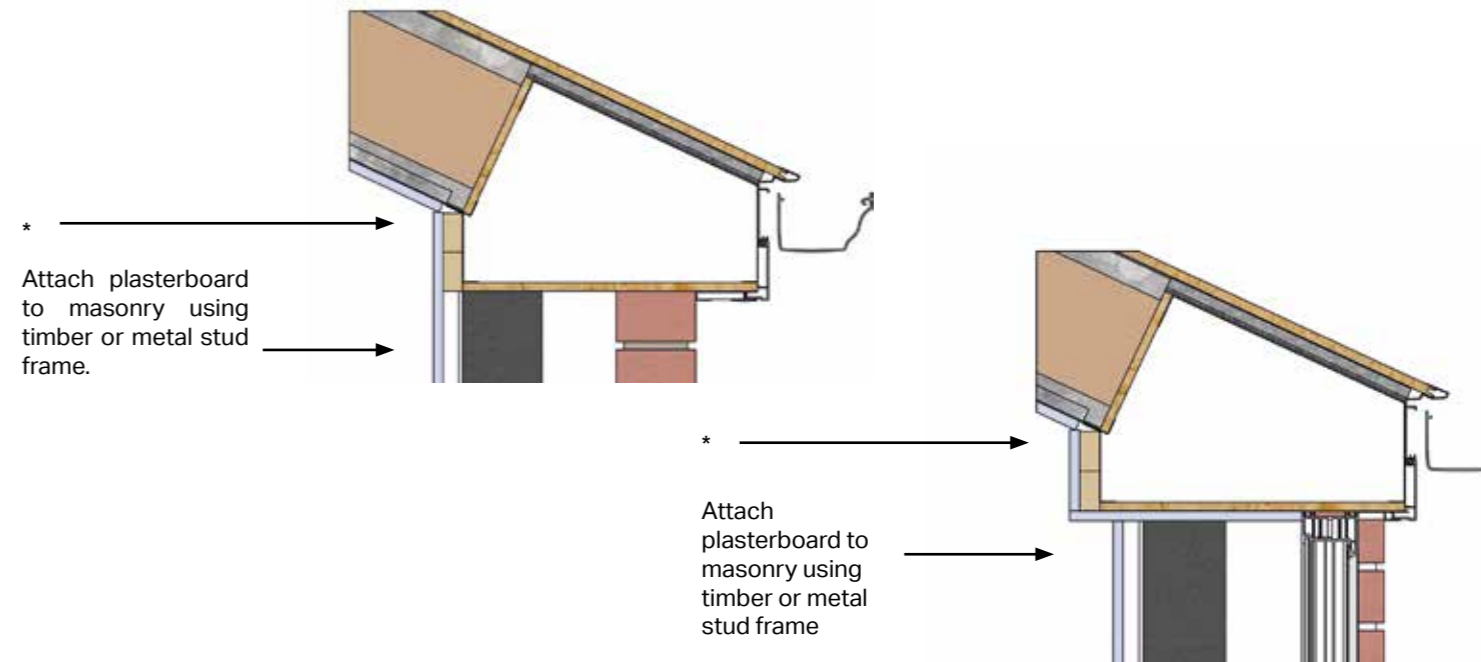

PLASTERBOARD GUIDELINES (SUPER-INSULATED COLUMNS)

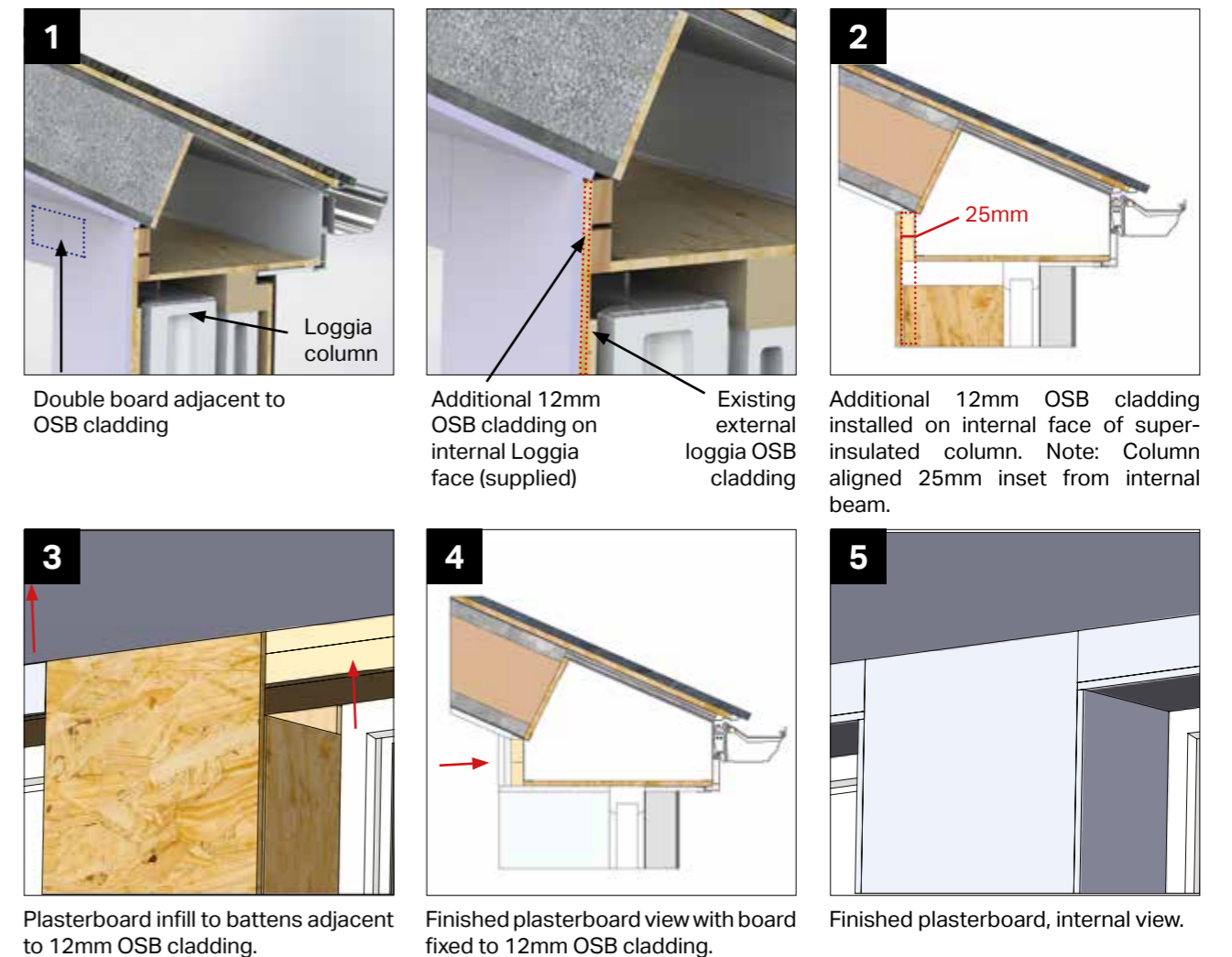

INSTALLATION - FITTING ROOF GLAZING

FOLLOW MAIN GUIDE UP TO PAGE 23, STEP 40 THEN FOLLOW THIS SECTION

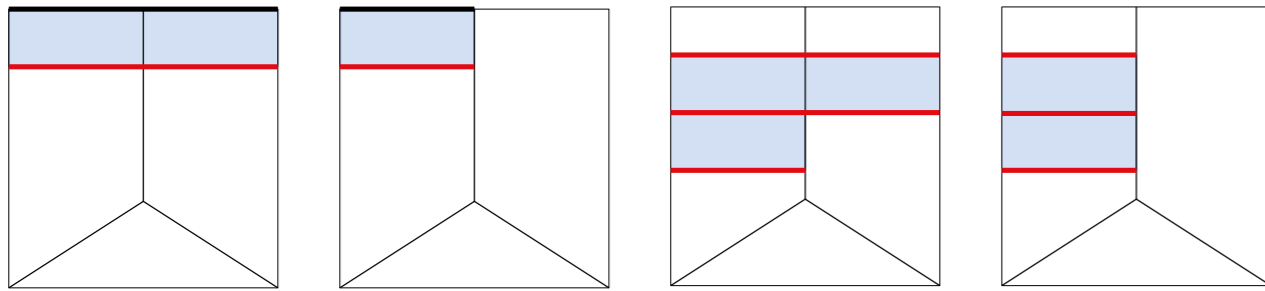

KEY

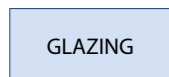

STARTER BAR (GLASS)



TRANSOM BAR (GLASS)

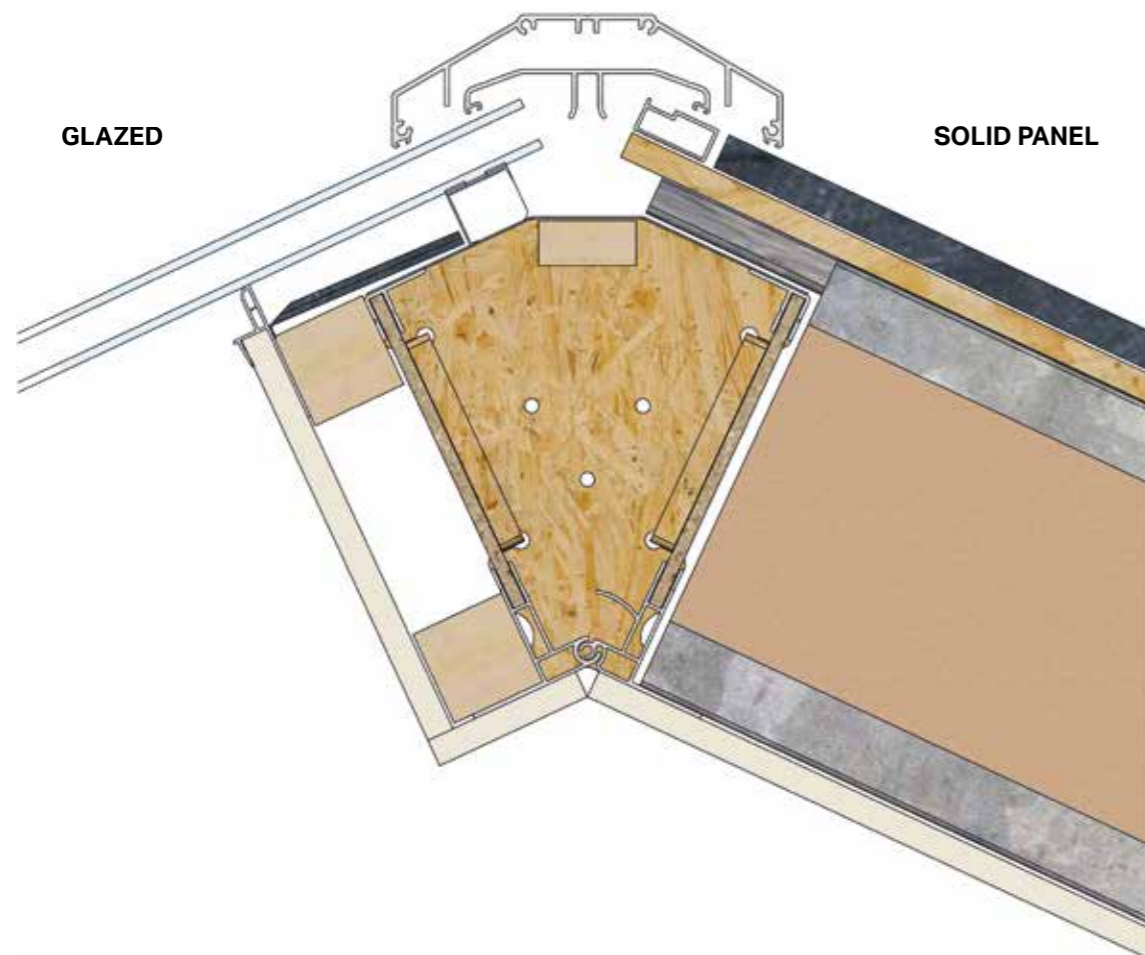
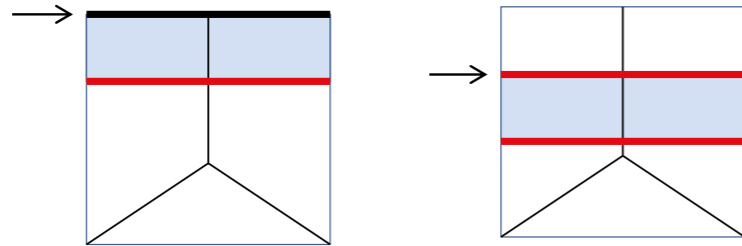

INSTALLATION - FITTING ROOF GLAZING

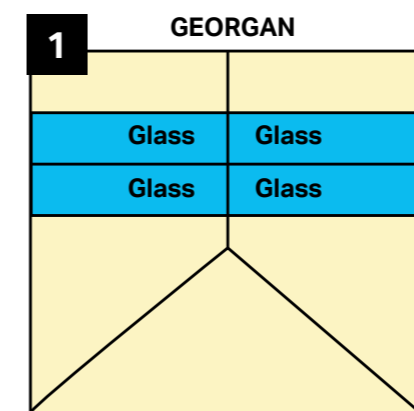

THE MAIN GLAZING GUIDE IS BASED ON THIS DESIGN



When installing 24mm double glazed units, the box beam OSB face will be marked with the vertical lines which indicate glazing bar centres. On the marked lines, locate to the top edge of the box beam the appropriate box beam shoes (NRBE 001 or NRBE 002) supplied. Fix to the beam using 8 x 4.2mm x 25mm wafer head self drill screws (NRTS 050) provided.



Place glazing bar into the box beam shoe positioned and fitted at step 2. Ensure the glazing bar is at 90 degrees to the box beam. The mark with a pencil each side of the bar at the ridge. Remove the bar.



Between the marked lines fit the upper ridge side glazing bar shoe. Fix to the ridge using 8 x NRTS050 screws provided.



Lower the glazing bars into the shoes. Check diagonals of the glazing apertures are equal. Ensure when fitting the glazing bar that the silver insulation attached to one side of bar, abuts the adjacent roof panel.



Fix all glazing bars into ridge and box beam shoes, using 8 (4 ridge shoes, 4 box beam shoes) with NRTS050 screws provided.

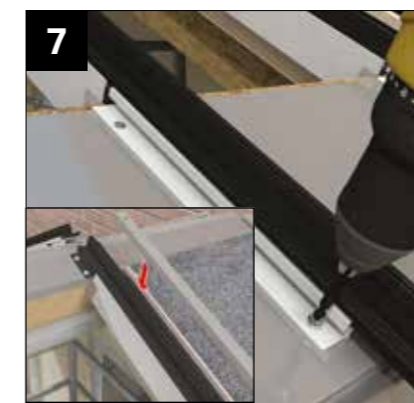

Finally secure glazing bars to external face of ridge and box beam using 6 (4 into box beam, 4 into ridge) NRTS050 screws provided.



Lower into position all yellow labelled panels working from hip bar towards glazed panel and from host wall to glazed panel. Do not snip binding cords.



Then lower into position the red labelled expandable panel. Now snip all binding cords.

INSTALLATION - FITTING ROOF GLAZING



Reaching through the glazed panel opening fit the host wall external panel half clip, followed by the glazing bar half clip (see steps 43 to 46 pages 24 and 25) using WPCS020 4.8 x 38mm screws provided.



To secure the glazing bar offer the upper 'U' channel section. Screw up through into the bar within 200mm of the wall plate and box beam. Then at 500 centres. Using NRTS050 4.2 X 25mm screws provided. Then fix horizontally into OSB at similar centres.



Then fix the lower 'U' channel.



At the ridge fix the upper and lower plaster board timber battens (45 x 45mm) with screws (not provided) one fixing either end. The upper timber finishes flush with top of ridge. (See ridge cross section on page 40).

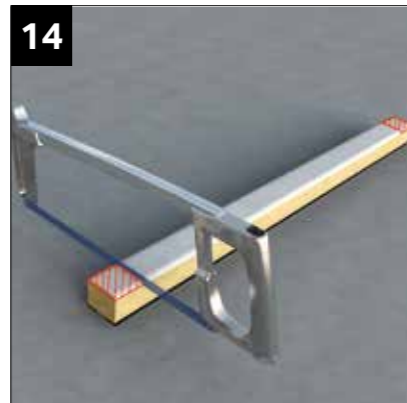

Cut to length the upper glazing support trim. Then, notch out the underside at each end to allow support to ride over glazing bar flanges.



Position glazing support trim, upper edge in-line with fold on ridge body (see ridge cross section on page 40). Secure using WPDS020 3.5 X 50mm screws provided.

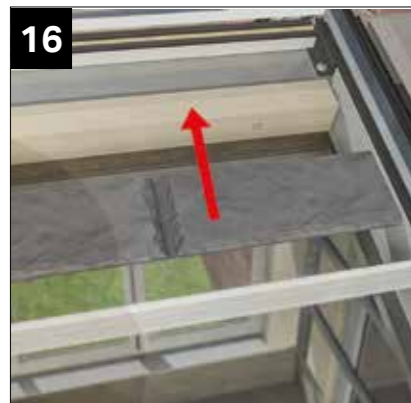

Slide into position above the upper timber batten onto the top surface of the ridge the upper tile screen. This will be trapped by the upper plasterboard PVCu trim once glazed.



The trim shown in position, once glazed (see ridge cross section on page 40). Fasten the plasterboard PVCu trim with a fixing at either end of the upper 45 x 45mm timber batten (provided).



At the box beam end of the glazing panel, locate aluminium glazing support trim between glazing bars. See inset at step 19 for location point.

INSTALLATION - FITTING ROOF GLAZING



Secure the glazing support section at 200mm ctrs using NRTS050 4.2 X 25mm screws provided.

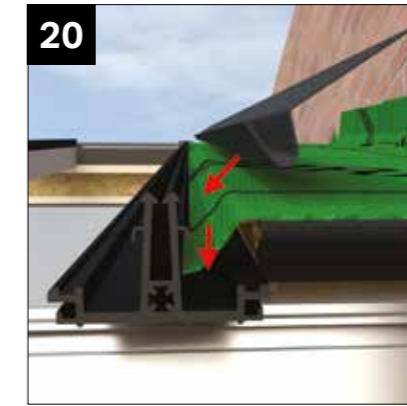

Where glazing is present, allow the membrane to overlap into the glazing bar as shown. The drainage channel can then be installed to clamp the membrane in place.

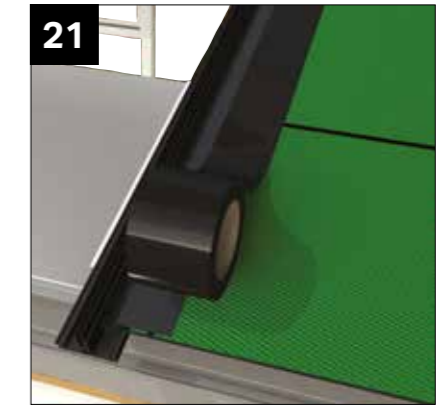

Tape the joint between the breather membrane and drainage channel as shown using weathering tape (supplied).

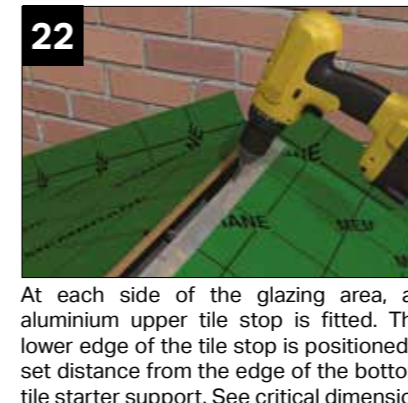

At each side of the glazing area, an aluminium upper tile stop is fitted. The lower edge of the tile stop is positioned a set distance from the edge of the bottom tile starter support. See critical dimension sheet for dimension A, see step 29. The tile stop is bedded down with clear low modulus silicone, then screwed at 300mm centres using (NRSF012) 4.8 x 38 pan head screws provided. Finally seal lower edge of the tile stop to underlayer again using clear low modulus silicone.



Fit the glazed ridge panel flashing trim to left and right side of ridge, (NRRI 011R right shown). These are bedded down using clear low modulus silicone.

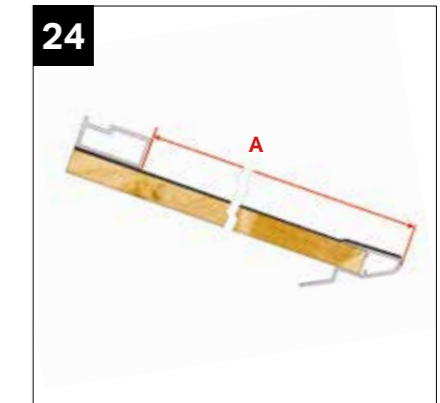

Dimension A given on critical dimension sheet. This gives distance from face of tile stop to outer edge of tile starter support.

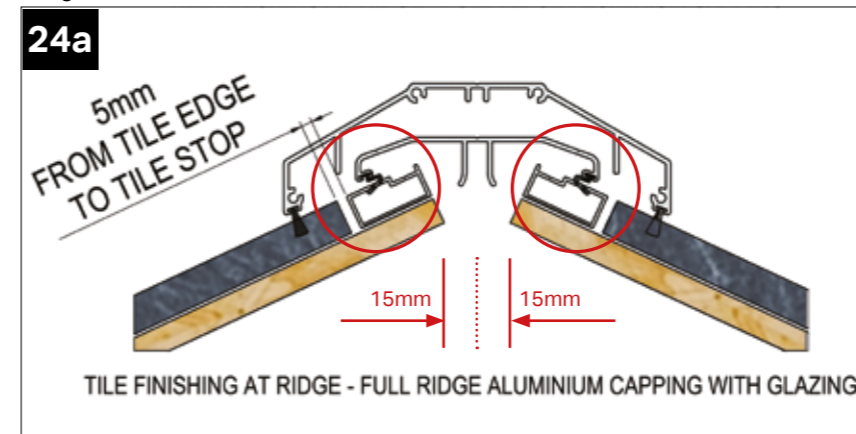

NOTE: CHECK FOR 30MM SPACE BETWEEN OSB BOARDS. THIS WILL ENSURE INNER TOP CAP SEALS ARE POSITIONED CORRECTLY ON THE TILES STOPS.

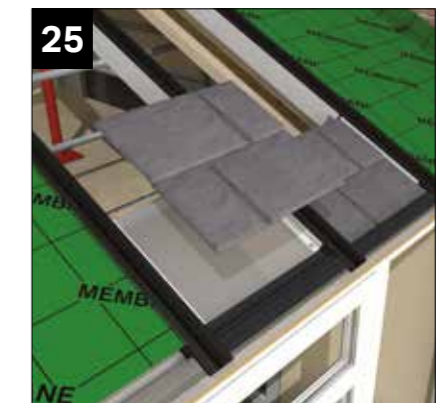

Position the box beam tile screens. Place in-line with adjacent tiling (not covering ventilation mesh) and secure with a single 4.2 x 25mm screw top centre (NRTS 050) provided.

INSTALLATION - FITTING ROOF GLAZING



Lay carefully into position the 24mm thick double glazed unit tight to the upstand on the lower glazing support section. See separate detail if fitting roof vent.



Prior to fitting the pre-notched glazing end profile, run a bead of silicone, low modulus (for none coated glass) or MS Polymer (self clean glass) immediately behind the co-extruded gasket before tapping down into position. Then seal each end to protect the seal.

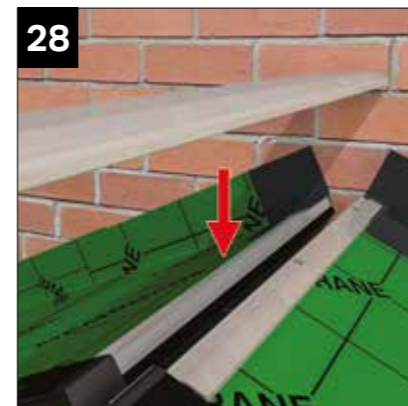

Lay aluminium ridge flashing cap. It is positioned 10mm away from the host wall. Then pre-drill the capping to suit steps 29 and 30.

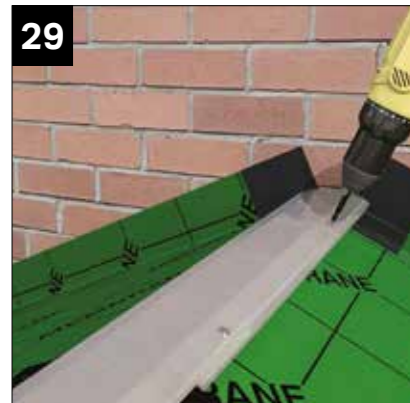

Over solid panel area screw down either side of the capping at 500mm ctrs into the upper tile stop using (NRTS 050) screws provided.

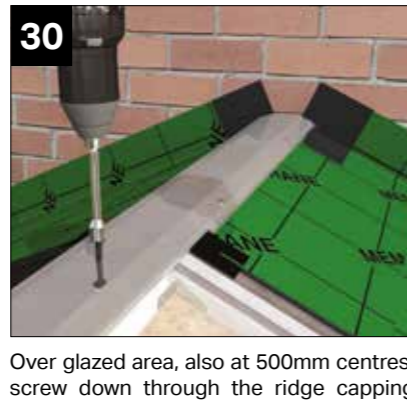

Over glazed area, also at 500mm centres, screw down through the ridge capping centre line using the longer 5.5mm x 90mm (NRRSA 005BL) screws fitted with G16 stainless steel sealing washer. **Run a continuous bead of silicone, low modulus (for non coated glass) or MS polymer (self clean glass) along the head of the unit tight to the Q LON gasket.**

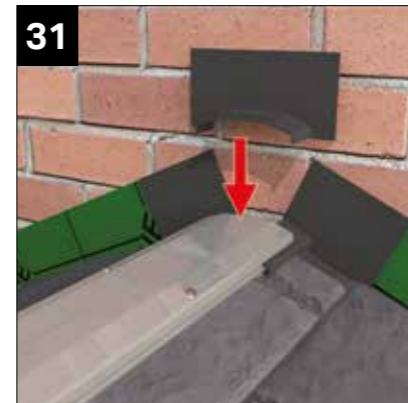

Seal and fit the rear host wall pre-formed flashing saddle (NRR1010). Using clear low modulus silicone.



Seal and fit the front radius end flashing kit using 250 x 250 square butyl sealing tape (supplied). Heat the sealing tape with a heat gun and position the tape over the ridge end (100mm from ridge end). Press firmly into place over the capping then make 2 slits (as indicated) before forming the final position.



When fitting the glazing top cappings **ensure you have the brush seal gasket covering the tiles and the QLon gasket on the glass**, prior to knocking the capping down.



Attach the aluminium transom end cap plates to the end of each glazing bar using 2 x 4.8 x 32mm pan head self drill screw (NRES 004) provided. Each screw comes with a 2 part coloured screw cap cover.

INSTALLATION - LEAN TO - SOLID

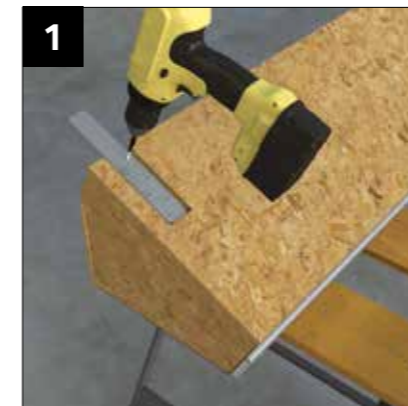

ONLY IF GABLE FRAME STIFFENERS SPECIFIED: Fix the aluminium gable beam fixing plate to the underside of the box beam using 6 x RRX 025 screws. **NOTE: ALIGN PLATE 'V' NOTCH GROOVES WITH EDGE OF BEAM.**

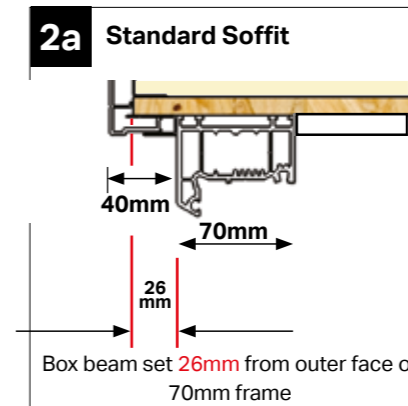

Lean-To set out projection as shown above (standard soffit) ensure to centralise box beam along the front frame to achieve equal soffit overhang.

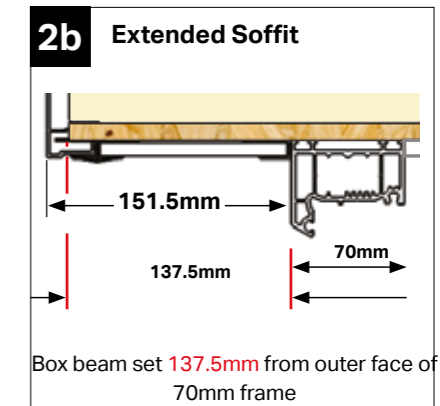

Lean-To set out projection as shown above (extended soffit).



Apply low modulus silicone to the head of frames local to beam area before lifting the box beam into position. Temporarily fix the box beam in position.



Check the beam is level. Pack off top of frames if necessary. Insert a support prop under the beam. Adjust the height of the prop to ensure the beam is level **side to side as well as in length.**



Fix a prop into the steel section of the beam face as shown above. Props should be at max 2000mm centres within 250mm from each corner (prop fixings NOT SUPPLIED) 75x50 timbers props NOT SUPPLIED.

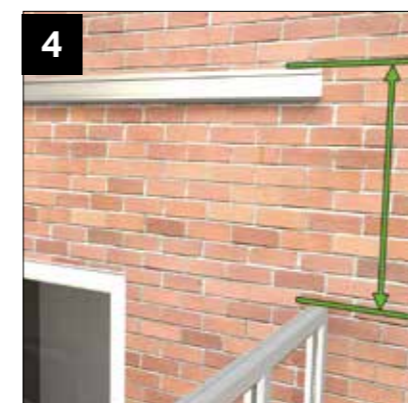

Fix the half-ridge (cut to internal frame) at the height given in the critical dimensions sheet, ensuring the ridge is level. Adjust the half ridge height if necessary. **NOTE: DIMENSION IS FROM UNDERSIDE OF BOX BEAM TO TOP EDGE OF HALF RIDGE (SEE CROSS SECTION ON PAGE 50).**

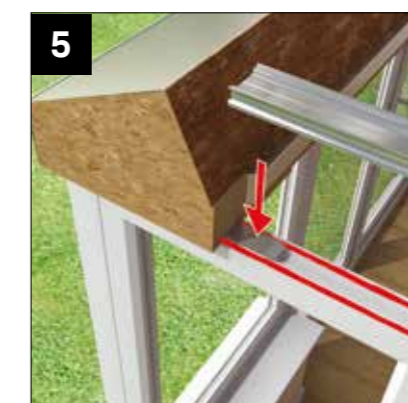

ONLY IF GABLE FRAME STIFFENERS SPECIFIED: Silicone the head of the frames. Place the aluminium gable frame stiffener with V-groove uppermost.



Fix the gable frame stiffener to the aluminium beam fixing plate using 4 x RRR025. Secure along the length of the stiffener at 500mm centres into frames (fixings not supplied).

INSTALLATION - LEAN TO - SOLID



The 4 fixing positions.

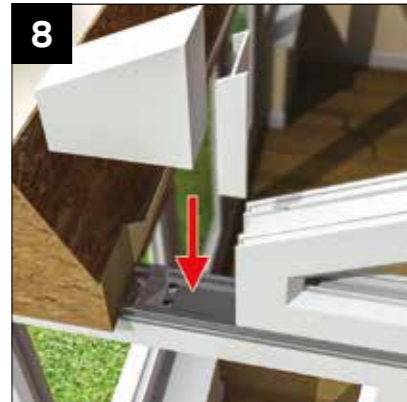

Apply silicone to the gable frame stiffener and fix the gable frame. Trial fit the infill wedge and coupler prior to final fixing.

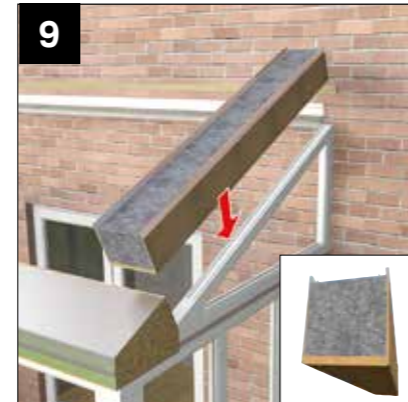

Locate end panel (s) onto the rear wall plate shelf and box beam shelf. Ensure OSB boarding on end of gable panels are flush with the end of the beam. Note: if there is glazing against a return wall see page 25. Marked with a yellow label, all gable end panels are supplied with OSB (timber panels) to the inside face. **DO NOT SNIP RETAINING STRAPS.**



After checking the correct overhang secure the gable panels by screwing up through the head of the frames. Fixings need to be within 200mm of each corner (dependant on access) and at 450mm centres using for example, 4.8mm x 80mm screws; not supplied.

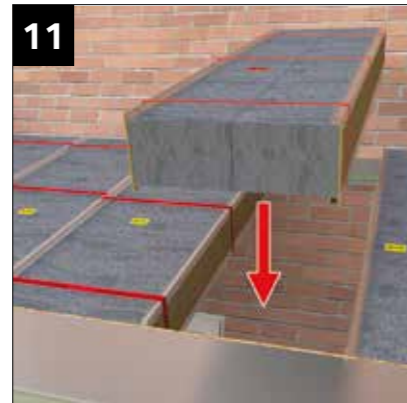

Working from LEFT to RIGHT, continue to install yellow labelled panels one at a time. Finally, lower into position the expandable roof panel (marked up with a red label). **DO NOT SNIP RETAINING STRAPS.**



The red labelled panels are always installed last. **DO NOT SNIP RETAINING STRAPS.**



With the expandable panel in position, snip all the retaining straps.



The expandable panel will expand sideways to take up any remaining gap.



When aligned (ensure external panel clip butts upto aluminium gutter channel, see red arrow) use a robust mallet to knock down the external panel locking clips (use a short length of timber to protect the clip from indentations).

INSTALLATION - LEAN TO - SOLID



Finally secure the external clips using WPCS020 4.8mm x 38mm self drilling screws provided. **NOTE: do not stand on the panels to secure the external clips.** Tip: on greater projections secure the clip to the beam (as step 16). Then fit the first row of OSB boarding, this will allow easier access to secure the panel clips further up the roof.

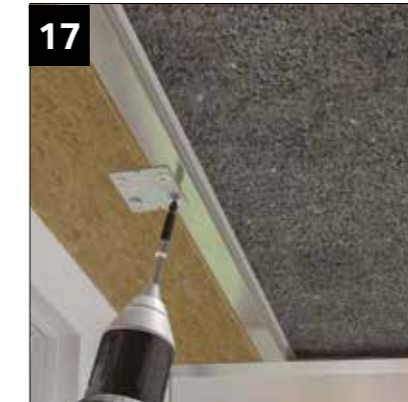

When all external panel clips are installed, fix (at 1 metre centres) using the supplied gable tie-plates WPPC002 using 4 x NRTS050 screws provided.

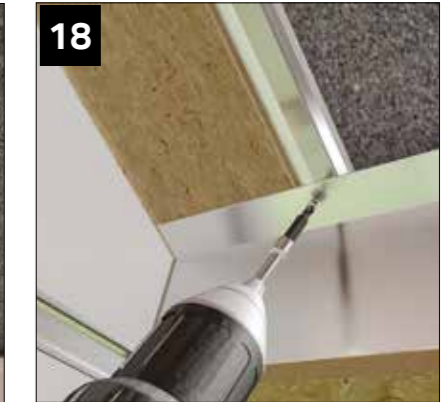

Secure the gable end panel (s) only by screwing up through the box beam shelf and the upper half ridge shelf using 1 x NRTS050 screws provided.



Now offer into position the pre-drilled internal panel clips. Again, use timber packer to prevent indentations to the internal clip. **NOTE:** short lengths, tap into position. Longer lengths, follow sequence steps 22-24.



Firstly secure into the panel (at the ridge end) using dry wall fixing screws WPDS020 **NOTE: See method of alternate tightening as shown 22 to 24.**



Secure into the panel (at box beam end) as previous image. **Again, note method of alternate tightening sequence 22 to 24.**

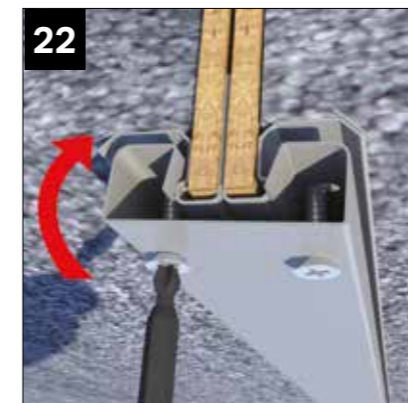

Loosely tighten alternative screws to enable easy clamping of internal clips.

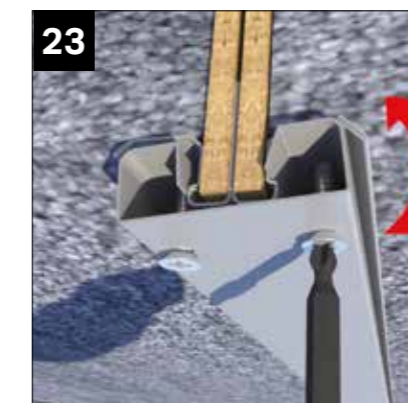

One side then the other.

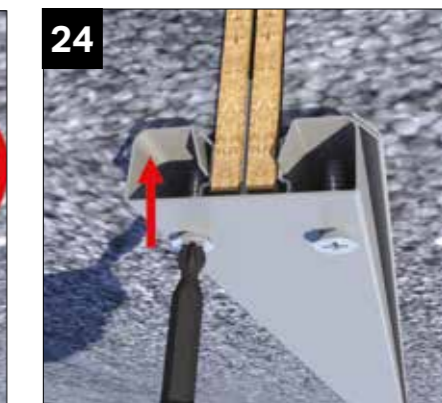

Fully clipped into position.

INSTALLATION - LEAN TO - SOLID



Secure to the half ridge body, the upper attachment plate using 2 x CHAA 006 fixings.



Finally secure to box beam support shelf the lower attachment plate using 2 x CHAA 006 fixings.

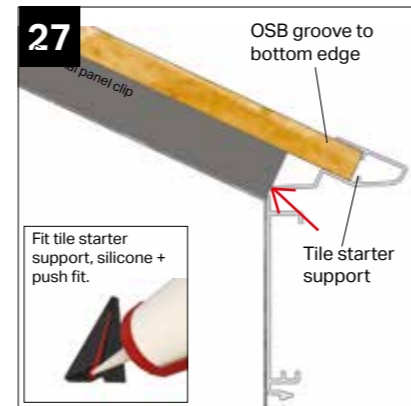

Having silicone sealed the tile starter support onto end of OSB, place tight up to the end of the external panel clip (see red arrow).



Following location plan, locate first row of OSB panels around the roof using tile starter support section to position. Ensure OSB sheets are the right way up, orientation.

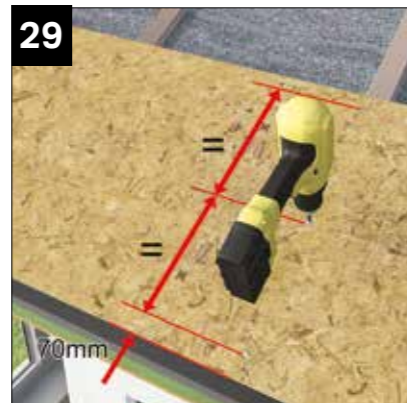

With OSB in position fix board 70mm up from tile starter support and 70mm down from upper edge followed by 1 x central fixing. NOTE: Fixing position at step 30.

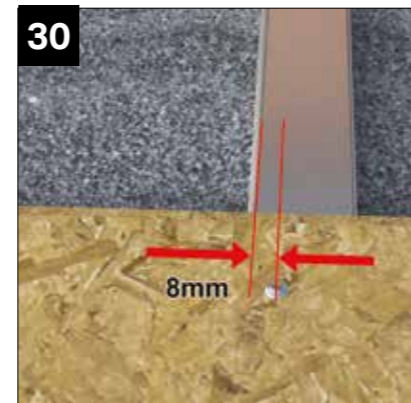

All boards to be secured 8mm in from either edge. 3 fixings per clip position using NRPS050 4mm x 25mm screws, provided.



Where required support OSB board at butt joints using timber battens supplied. Battens are 65 x 19 x 700mm long (NRPB010). Only required over box beam. All OSB board edges are tongue and grooved to allow positive location. Continue to board from bottom to top (box beam to wall plate).

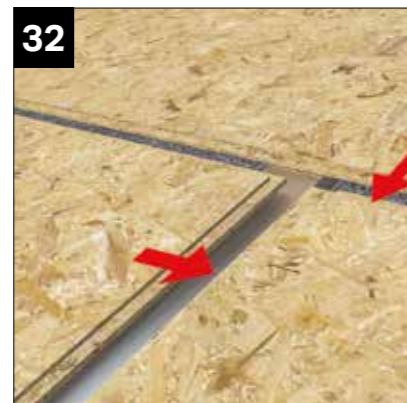

A timber support batten needs to be fixed to the host wall to support the OSB, see image on page 13. NOTE: before fitting last row of OSB at the half ridge, ensure to fully insulate with supplied mineral wool between top of panels and host wall. See image page 13.

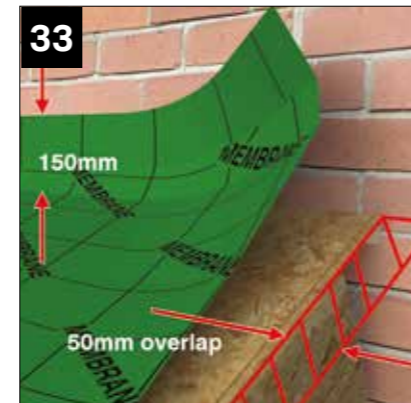

Cut the breathable membrane underlayer to the width of the roof deck plus 50mm over hanging the OSB barge-board at each end and 150mm up the host wall.

INSTALLATION - LEAN TO - SOLID

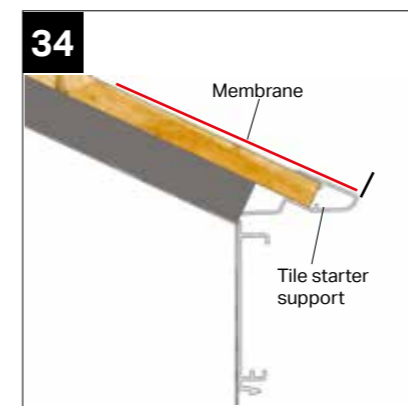

The breathable membrane is aligned to the front edge of the tile starter support.

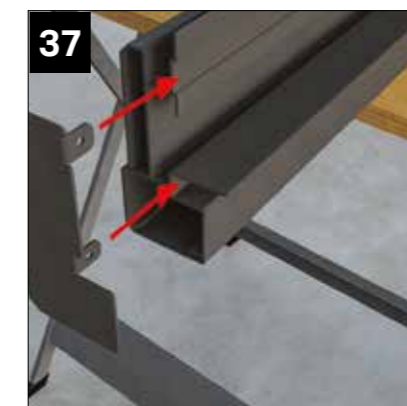

Insert the aluminium dry verge end cap into a square cut end. The end adjacent to the house will be angled to run parallel with the house wall.

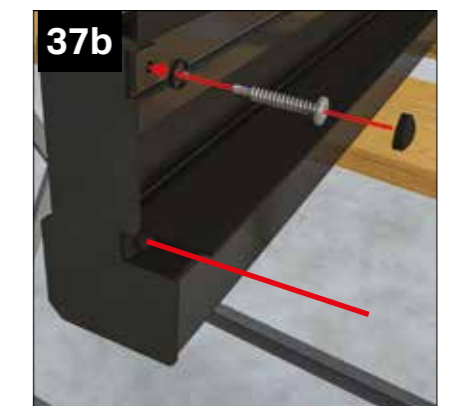

Fix the end cap in place using 2 x NRES 004 4.8 x 32 pan head screws with cover caps.



Apply a bead of clear low modulus silicone to the underside of the dry verge.

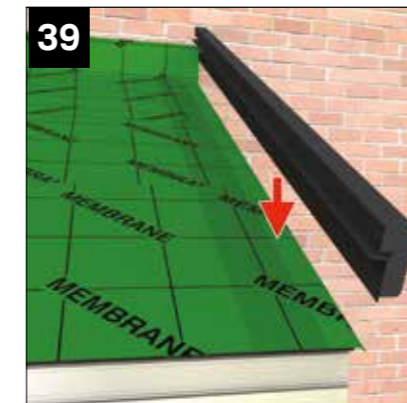

Position the dry verge on the top edge of the bargeboard, with the membrane folded down the face of the barge board.



Fix the dry verge to the OSB using NRTS 050 screws at 300mm centres. Ensure membrane overlaps into dry verge for drainage.

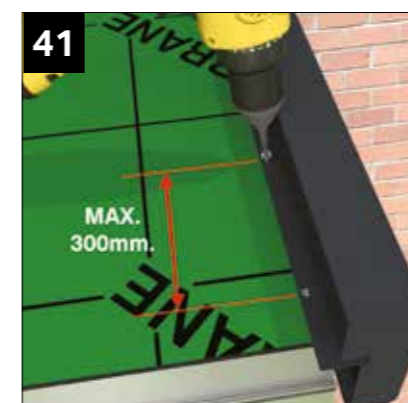

Fix the dry verge to the roof deck with NRTS 050 screws, max 300mm centres.



See separate tiling guide for details on tiling method.



If obstructed on the RHS, remove 15mm from the clips to allow fitting.

INSTALLATION - LEAN TO - SOLID



44 Fit soffit trims to underside of barge boards.



45 Fit pvc barge board box ends and barge board



46 Fit 90° external corner cover trims

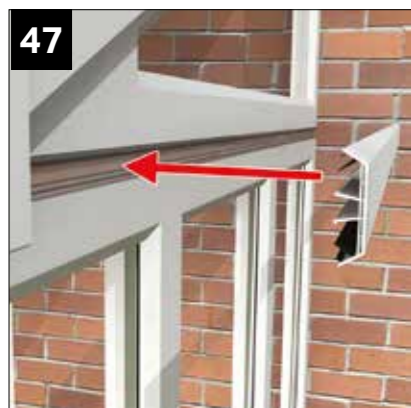

47 Fit internal and external gable stiffener claddings (if ordered). **NOTE:** Aluminium stiffer and cladding may need notching/routing for frame drainage.



48 Lead flash to existing host wall.

LEAN TO - SOLID ROOF - HALF RIDGE CROSS SECTION

*Set out height given on critical dimension sheet

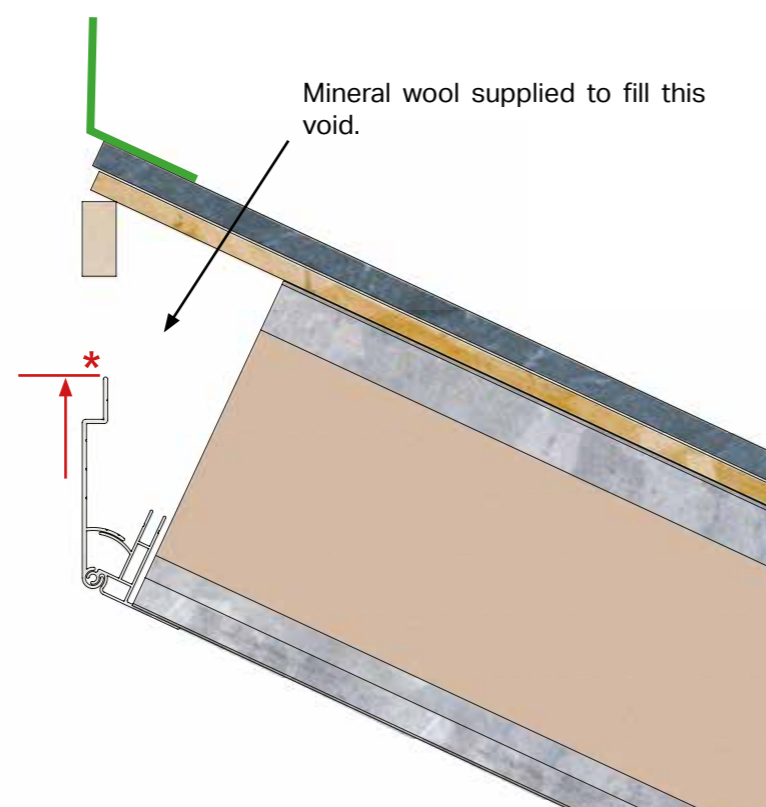

INSTALLATION - LEAN TO - GLAZED

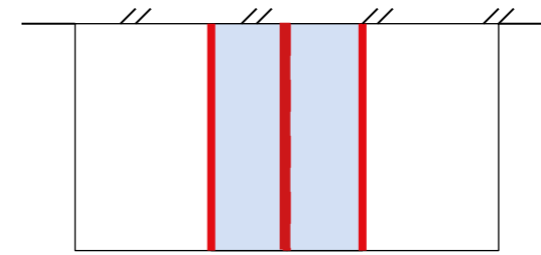

— STARTER (GLASS)
— TRANSOM

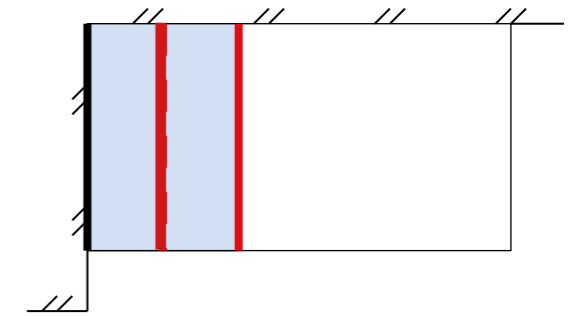

PANEL
GLAZING

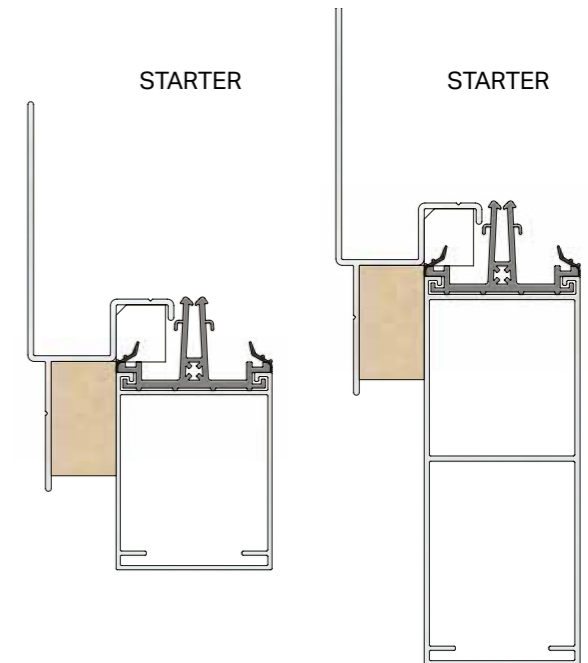
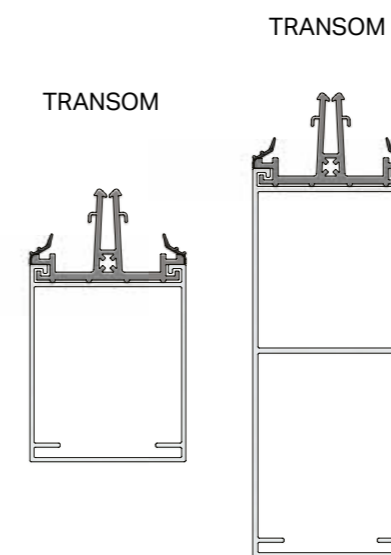

LEAN TO - GLASS ROOF - HALF RIDGE CROSS SECTION

*Set out height given on critical dimension sheet

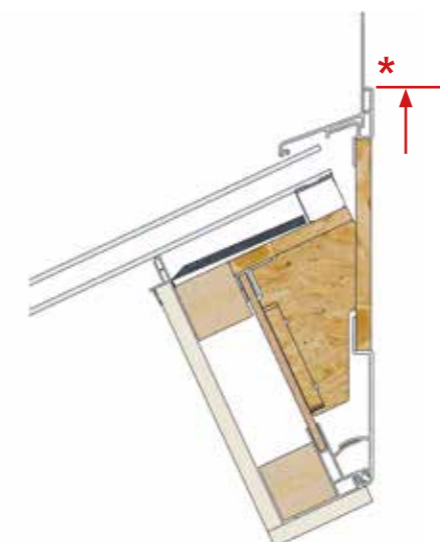

INSTALLATION - LEAN TO - GLAZED

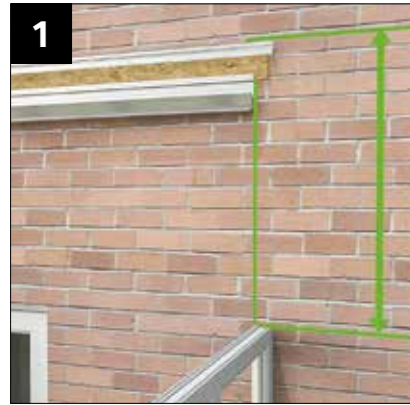

Position front box beams on frames. Ensure equal overhang at each end. Support / prop and level as page 45 steps 3a and 3b. Fix the half-ridge (cut to internal frame) at the height given in the **critical dimensions sheet**, ensuring the ridge is level. Adjust the half ridge height if necessary. NOTE: DIMENSION IS FROM UNDERSIDE OF BOX BEAM TO TOP EDGE OF HALF RIDGE SEE PAGE 51.

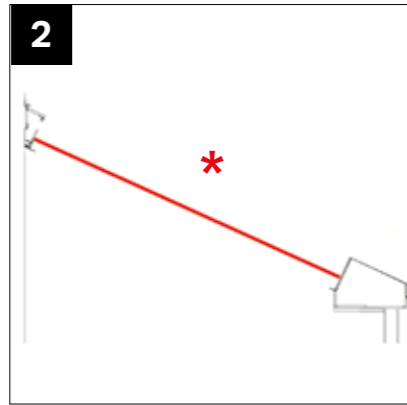

* Check this dimension from the **critical dimensions sheet** supplied. Fitters tip: cutting a length of timber to this length will enable you to set the panels correctly. NOTE: pack the half ridge off the host wall if not flat.



When installing 24mm double glazed units, the box beam OSB face will be marked with the vertical lines which indicate glazing bar centres. On the marked lines, locate to the top edge of the box beam the appropriate box beam shoes (NRBE 001 or NRBE 002) supplied. Fix to the beam using 8 x 4.2mm x 25mm wafer head self drill screws (NRTS 050) provided.



Place the glazing bar into the box beam shoe (fitted at step 3) ensure the glazing bar is at 90° to the box beam and half ridge.

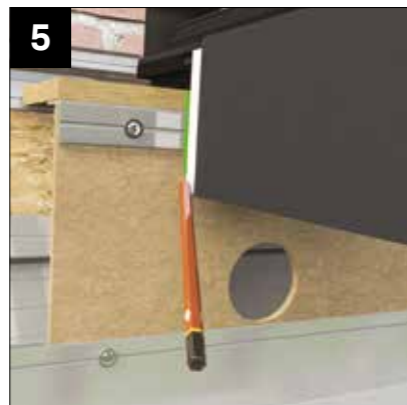

With the glazing bar at 90° to the box beam. Mark the rear wallplate as shown.



Remove the glazing bar. Offer to the marked vertical line the wall plate glazing bar shoe. Position and secure using 6 x NRTS050 4.2 X 25mm screws provided.



Lower into position all glazing bars. Check diagonals of the glazing apertures are equal before proceeding with step 8.



Secure at the wall plate using 4 x NRTS050 4.2 X 25mm screws provided.



Secure at the box beam using NRTS050 4.2 X 25mm screws provided.

INSTALLATION - LEAN TO - GLAZED

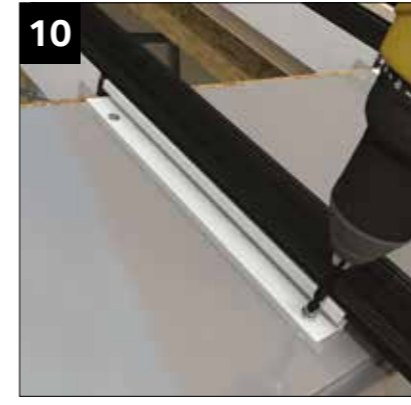

Secure glazing bar to wallplate and box beam, again using 2 at top and 4 into box beam using NRTS050 4.2 X 25mm screws provided.

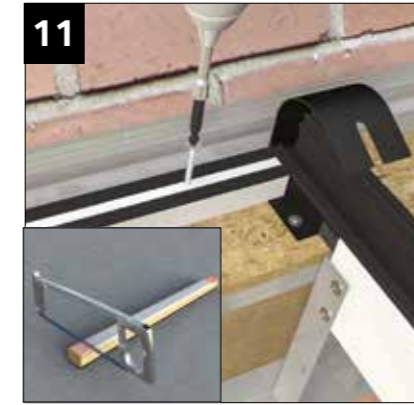

Turn the upper wall plate glazing support trim upside down and cut small notch into each end to allow support trim to sit flat onto the OSB board and tight into the bars. Secure the upper wall plate glazing support trim using 2 x WPDS 020 3.5 x 50mm screws provided.



Having installed each gable end panel ensuring each side of the panel is flush with the end of the box beam, continue to install standard (yellow labelled) panels before fitting expandable (red labelled) panels.

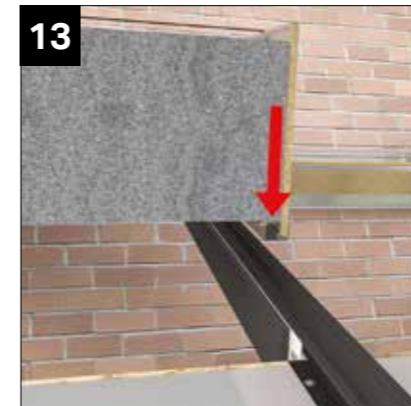

Note: each panel that abuts a glazing bar will be fitted with a half-clip. Remember to fit the external full and half clips as you install each panel. This will negate the need to stand on the roof.

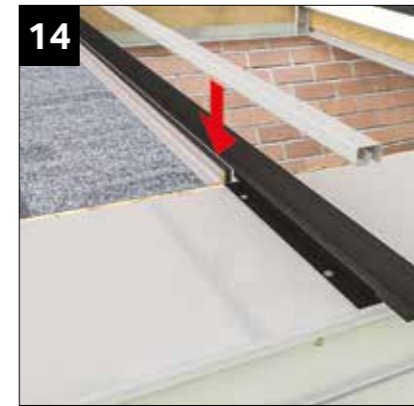

The external half clip being installed (see solid roof section for fitting of external and internal panel clips).



To secure the glazing bar offer the upper 'U' channel section. Screw up through into the bar within 200mm of the wall plate and box beam. Then at 500 centres. Using NRTS050 4.2 X 25mm screws provided. Then fix horizontally into OSB at similar centres.



Then fix the lower 'U' channel.



At the wall plate fix the upper and lower plaster board timber battens (45 x 45mm) with screws (not provided) one fixing either end. The upper timber finishes flush with OSB board.



At the box beam end of the glazing panel, locate aluminium glazing support trim between glazing bars. See inset at step 19 for location point.

INSTALLATION - LEAN TO - GLAZED



Secure the glazing support section at 200mm ctrs using NRTS050 4.2 X 25mm screws provided.

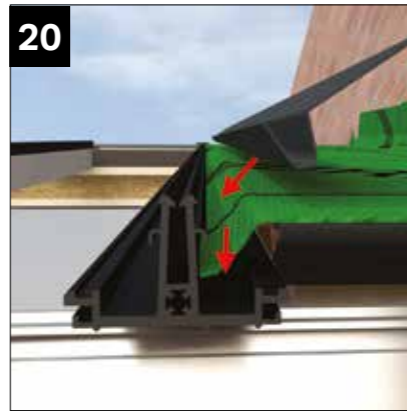

Where glazing is present, allow the membrane to overlap into the glazing bar as shown. The PVCu drainage channel can then be installed to clamp the membrane in place.

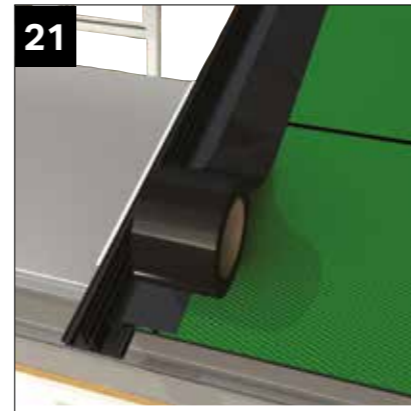

Tape the joint between the breather membrane and drainage channel as shown using weathering tape (supplied).



At each side of the glazing area, an aluminium upper tile stop is fitted. The lower edge of the tile stop is positioned a set distance from the edge of the bottom tile starter support. See critical dimension sheet for dimension A, see step 23. The tile stop is bedded down with clear low modulus silicone, then screwed at 300mm ctrs using (NRSF012) 4.8 x 38 pan head screws provided. Finally seal lower edge of the tile stop to underlayer again using clear low modulus silicone.

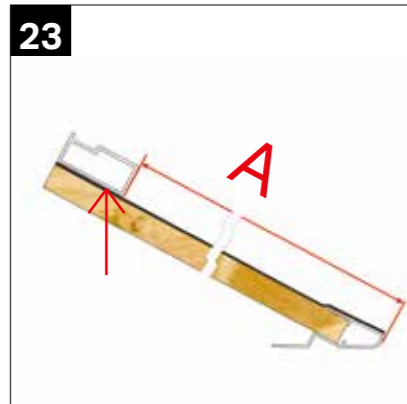

Dimension A given on **critical dimension sheet**. This gives distance from face of tile stop to outer edge of tile starter support.

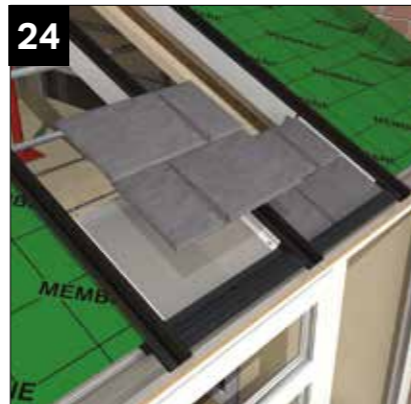

Position the box beam tile screens. Place in-line with adjacent tiling (not covering ventilation mesh) and secure with single 4.2 x 25mm screw top centre (NRTS 050) provided.

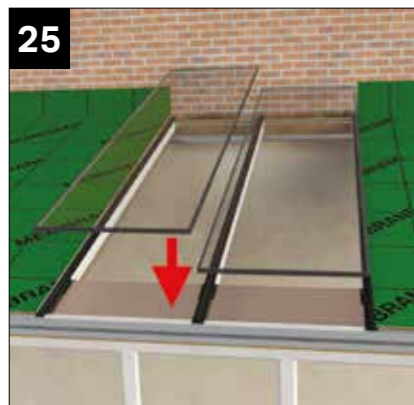

Lay carefully into position the 24mm thick double glazing unit, leaving sufficient clearance at the bottom edge to allow fixing of glazing end profile (fitted at 27). **NOTE: Image showing duo pitch roof.**



Slide into position the half ridge tile screen. This will be trapped into position when plaster boarded. **See separate tiling guide for details of tiling method.**



Prior to fitting the pre-notched glazing end profile, run a bead of silicone, low modulus (for non coated glass) or MS polymer (self cleaning glass) immediately behind, the co-extruded gasket before tapping down into position. Then seal each end to protect the seal.

INSTALLATION - LEAN TO - GLAZED



Centralise and fit the half ridge aluminium top capping. Secure using 4.0 x 13 CHAA06 screws provided at 500mm ctrs. **Beware: longer screws may penetrate glass.**



Finally knock on the aluminium glazing bar top capping. **NOTE: Ensure to check the brush seal runs down tiles and Q-lon gasket runs down the glass. Angled end of capping to half ridge, square end at box beam end.**



Attach the transom end cap plate to the end of each glazing bar using 2 x 4.8 x 32 screws NRES004 provided. Each screw has 2-part coloured cap cover.

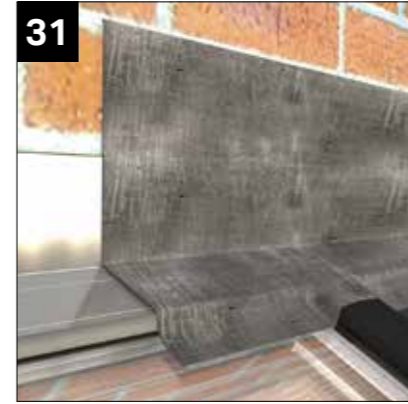

1200mm lengths of CODE4 lead overlapping 150mm and protruding 50mm, beyond nose of top capping to be used. Coat with patination oil to avoid oxidation run off.

INSTALLATION - LEAN TO - GLAZED TO ADJACENT WALL



1 Set the half ridge (wallplate) 5mm away from the host wall. The height (as step 6 page 47). Upper end of starter bar positioned so that glazing gasket aligns with glazing support trim. Secure to host wall within 200mm of half ridge and box beam plus at least one more equidistant between the two. Use resin anchors suitable to substrate - not provided.



2 Starter bar rides over the front box beam and drops into box beam shoe. Secure the shoe with 2 x (NRTS 050) screws.



3 Seal top edge of starter bar bung (NRRA002). Place the bung tight into the junction of the host wall and starter bar. Then seal with clear low modulus silicone.



4 Silicone the edge of the bung against the starter bar.



5 Secure the half ridge top capping into starter using (CHA006) screws provided.

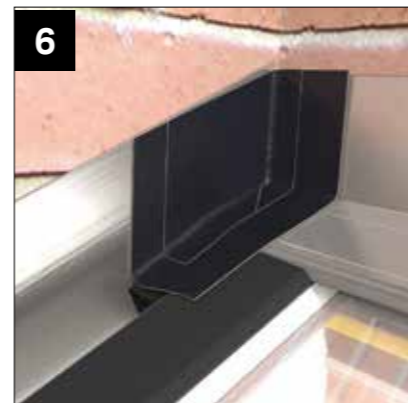

6 Using butyl tape supplied, ensure adequate seal between top capping and starter bar upstand.



7 Finally, manipulate code 4 lead over the glazing bar top capping and half ridge capping with overlaps as step 31 page 55.

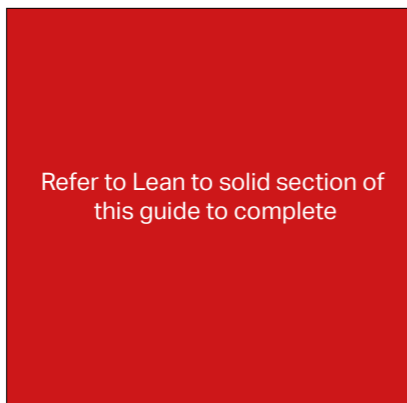

Refer to Lean to solid section of this guide to complete

INSTALLATION - GABLE END - GLAZED



1 Fix the aluminium gable beam fixing plate to the underside of the box beam using 6 x RRX 025 screws. **NOTE: ALIGN PLATE 'V' NOTCH GROOVES WITH EDGE OF BEAM.**



2 Apply low modulus silicone to the head of frames local to beam area before lifting the box beam into position. Temporarily fix the box beam in position.



3 For box beam/support and levelling see page 19 steps 8 to 11.

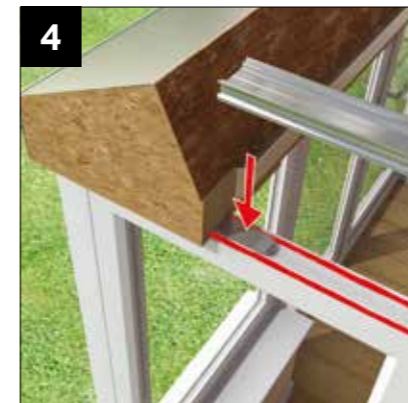

4 Silicone the head of the frames. Place the aluminium gable frame stiffener with V-groove uppermost.



5 Fix the gable frame stiffener to the aluminium beam fixing plate using 4 x RRR025. Secure along the length of the stiffener at 500mm centres into frames (fixings not supplied). Set out image 7 page 46.

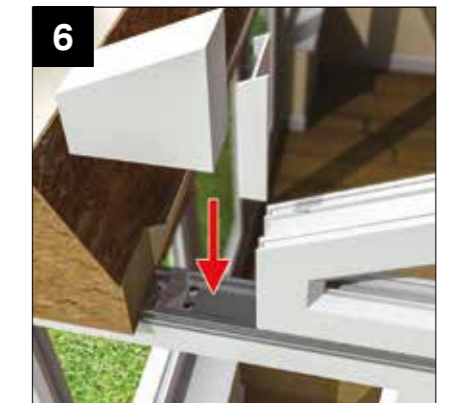

6 Apply silicone to the gable support extrusion and fix the gable frame. Trial fit the infill wedge and coupler prior to final fixing.

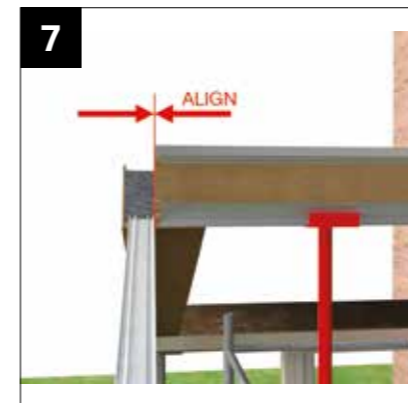

7 After installing the ridge as detailed on pages 22 and 23, images 25 to 35, check that the end of the ridge is in line with the gable end internal frame line.



8 Referring to the panel layout sheet, fit the first panels at the gable end as shown in images 9 and 10 on page 46.

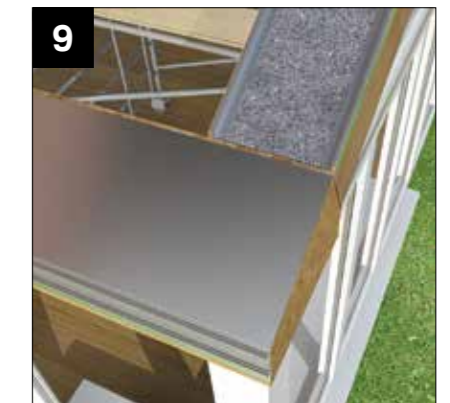

9 Check that the panel is in line with the end face of the beam and parallel to the gable frame.

INSTALLATION - GABLE END - GLAZED



10 Continue fitting the panels from the host wall.

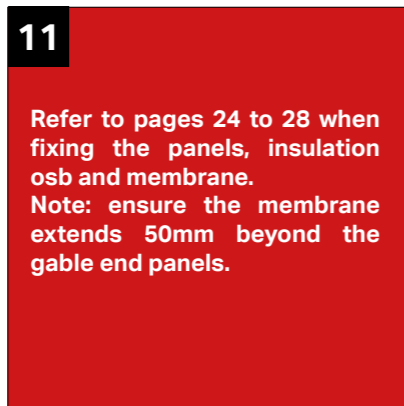

11 Refer to pages 24 to 28 when fixing the panels, insulation osb and membrane. Note: ensure the membrane extends 50mm beyond the gable end panels. **DO NOT SNIP RETAINING STRAPS.**

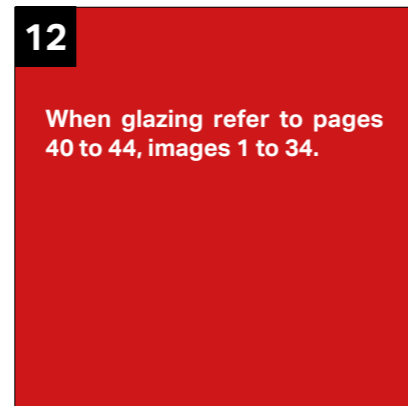

12 When glazing refer to pages 40 to 44, images 1 to 34.

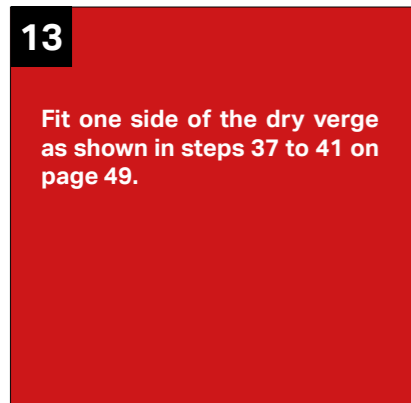

13 Fit one side of the dry verge as shown in steps 37 to 41 on page 49.

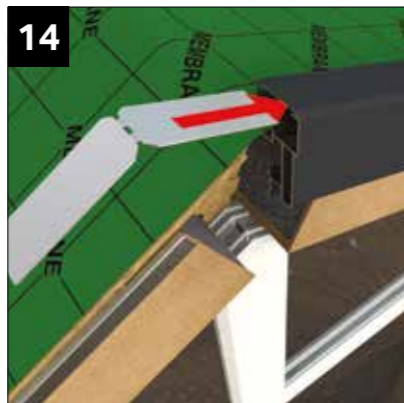

14 Fit gable cladding alignment strip into the aluminium dry verge.

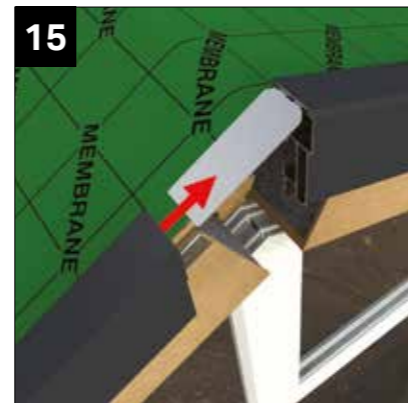

15 Fit opposite aluminium dry verge and point joints on upper and inner edges.

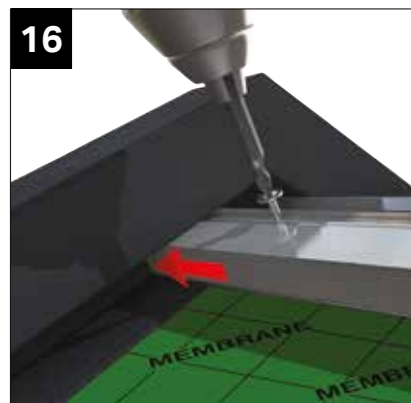

16 Slide tile stop under dry verge and fixed in place. See page 43 images 22 to 24 for details.

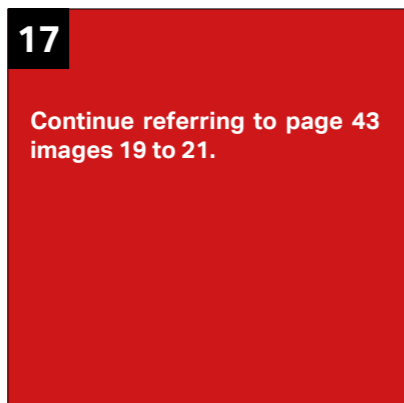

17 Continue referring to page 43 images 19 to 21.

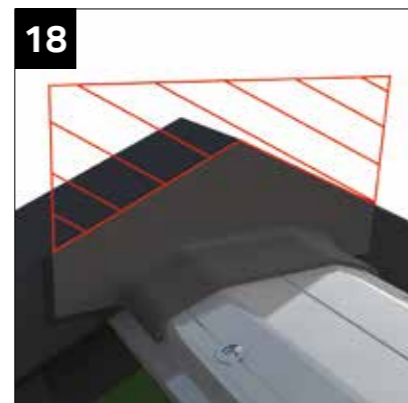

18 Fit the gable flashing. Mark and trim to fit the dry verge.

INSTALLATION - GABLE END - GLAZED



19 Apply clear low modulus silicone to the faces shown and refit.

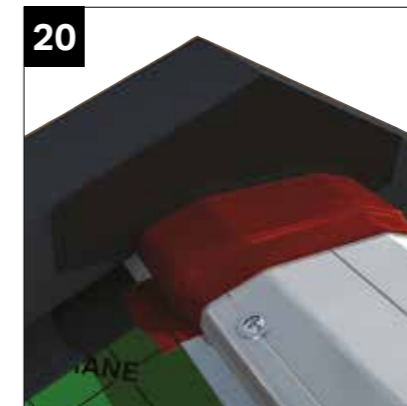

20 Fit first 200mm Butyl tape strip sealing the gable flashing to the ridge flashing cap.



21 Fit second 200mm Butyl tape sealing the dry verge to the gable flashing. Cut the tape to allow it to be folded as shown in the following two images



22 Fold down and press firmly into position.



23 Finally cover joint with a third layer.



24 Fit the ridge top capping using the NRRSA 005BL supplied.

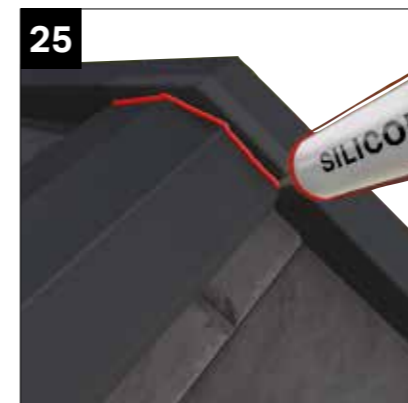

25 Apply clear low modulus silicone to the joint between the ridge top cap and the dry verge.



26 Fit the pre-cut fascia and eaves trims. See page 50, images 44 to 47 for more detail.

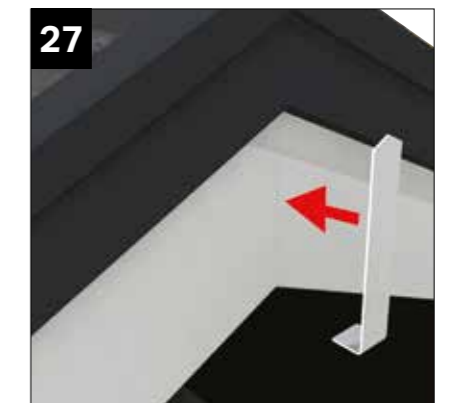

27 Fit the fascia ridge trim, modifying where necessary ensuring a neat finish.

INSTALLATION - GABLE APEX COVER

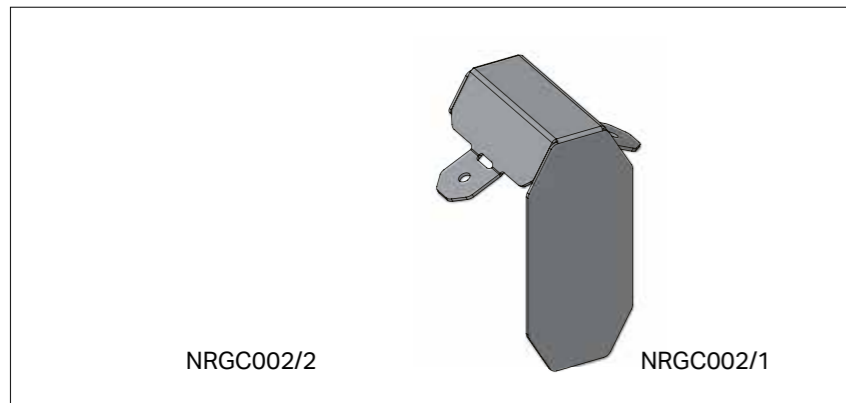

The gable apex cover is a product for an improved finish at the exterior apex of a duo-pitched gable roof. This new 2-part product is used to cloak the joint between two adjoining dry verge claddings.

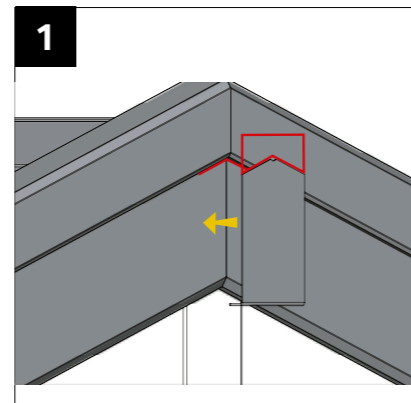

1 Scribe the lower part to fit beneath the step in the aluminium dry verge cladding as shown. Fix using a suitable silicone adhesive.

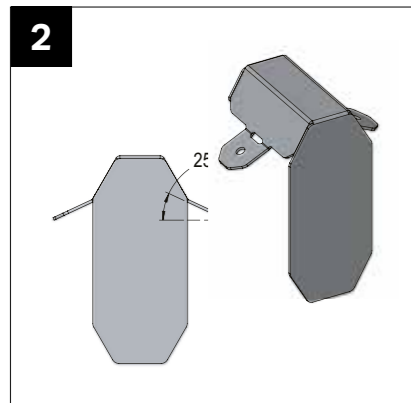

2 Bend the wings of the upper part to match the desired roof pitch – by default they are set to 25 degrees.

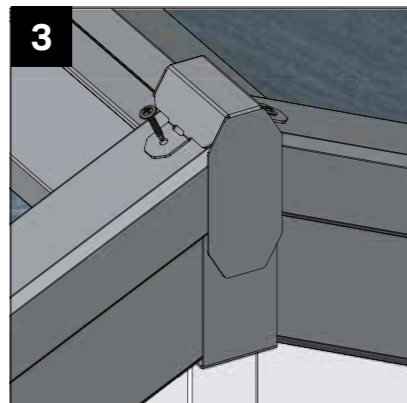

3 Position as shown and fix using 2 x NRTS 4.2 x 25 self drilling wafer head screws (supplied).

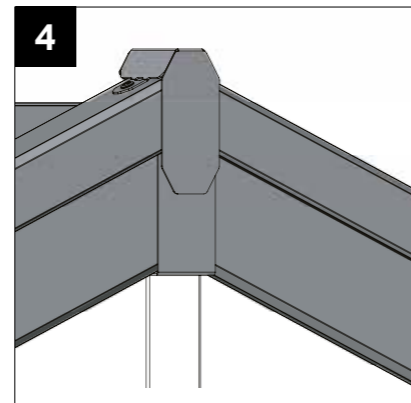

4 Finished installation shown above.

INSTALLATION - GABLE REINFORCEMENT BOX DETAIL

Detail may vary if fitting on brickwork. Refer to brickwork section.

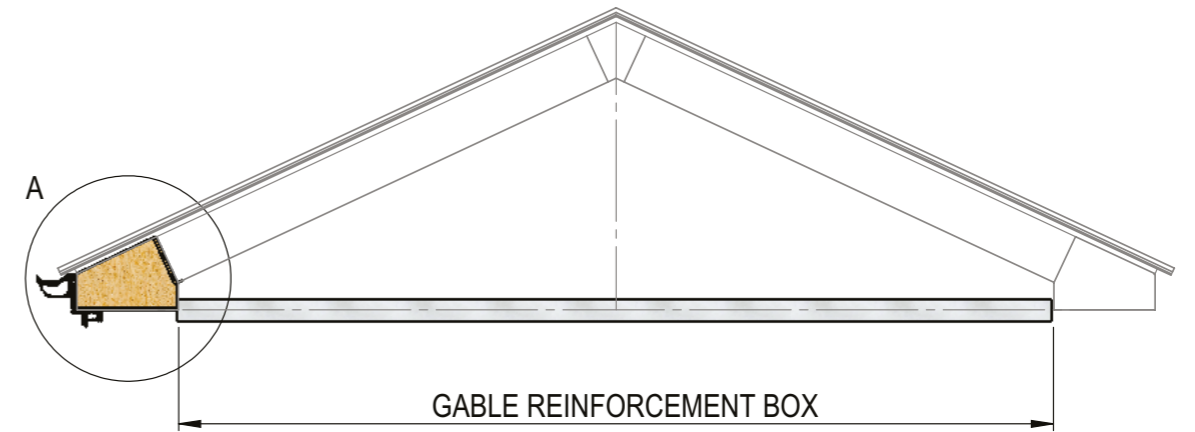

NOTE: A cill will be required if on super-insulated columns

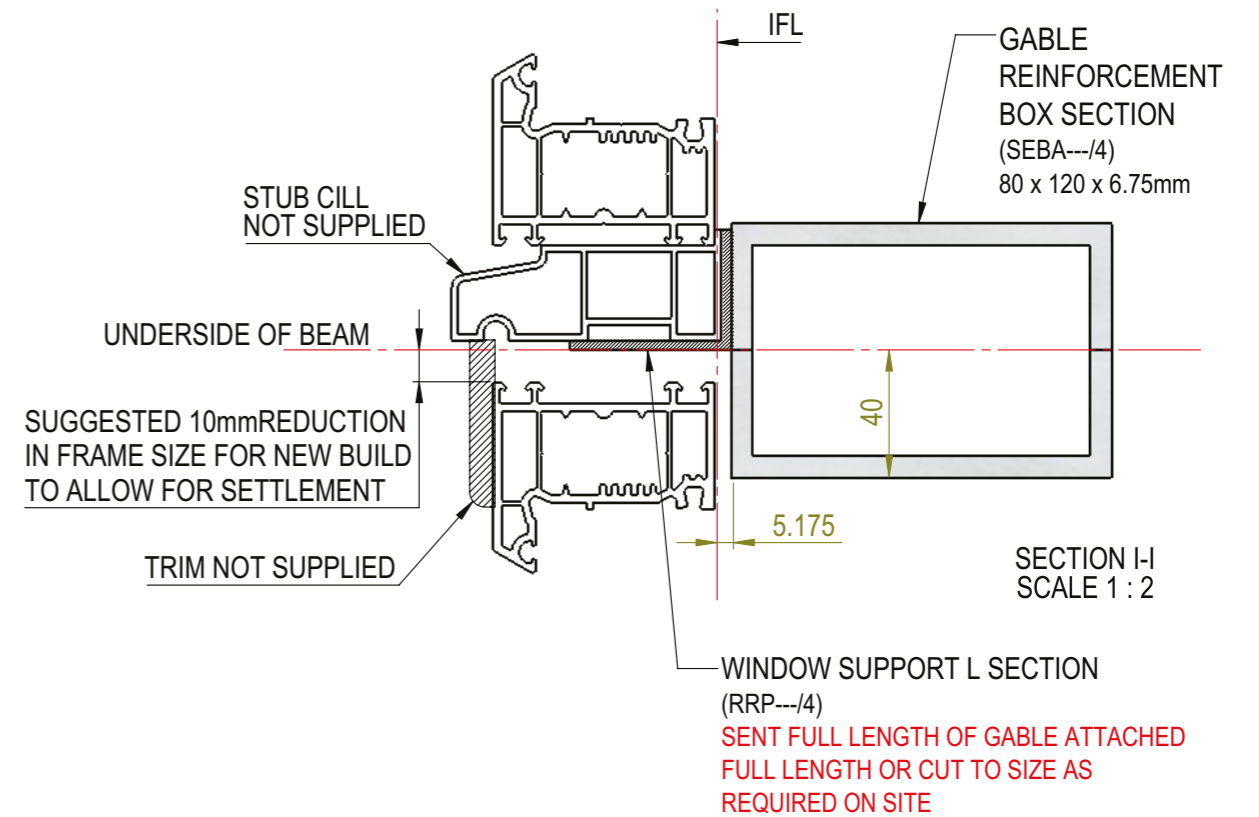

INSTALLATION - GABLE REINFORCEMENT BOX DETAIL

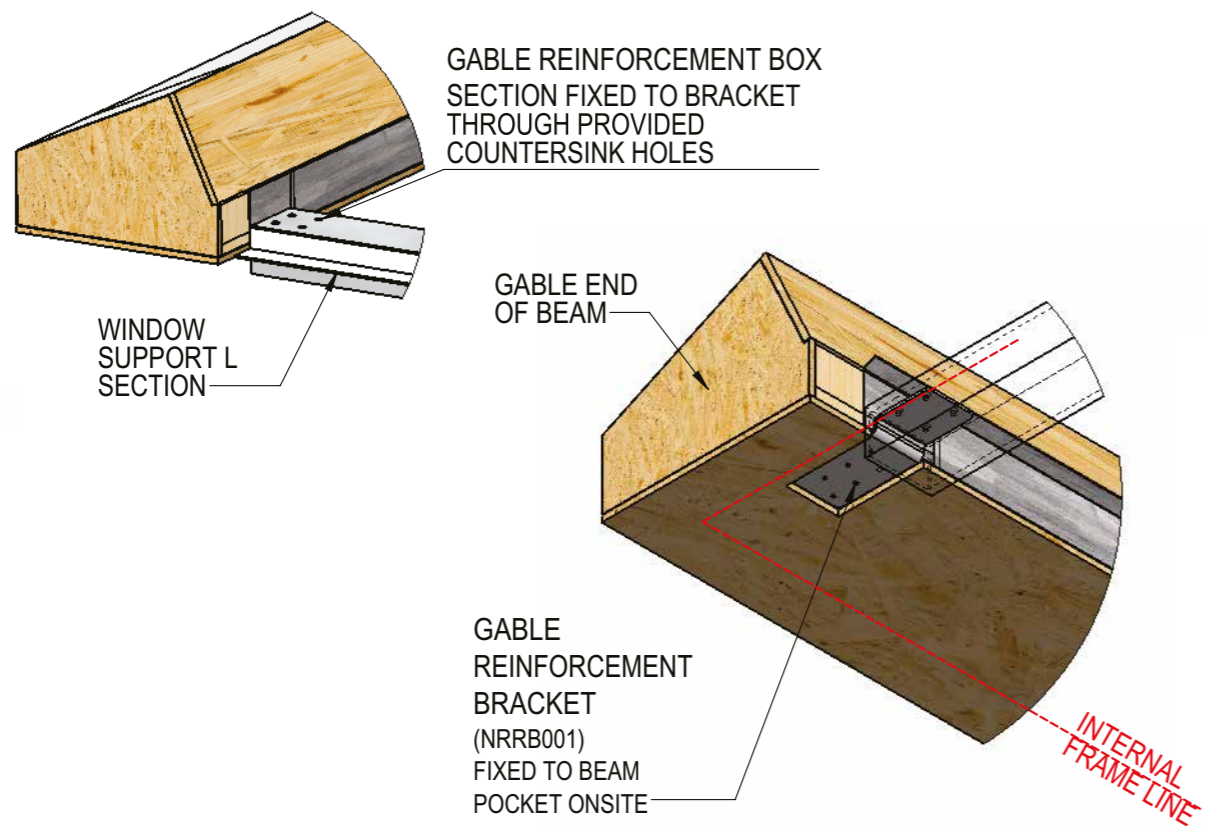
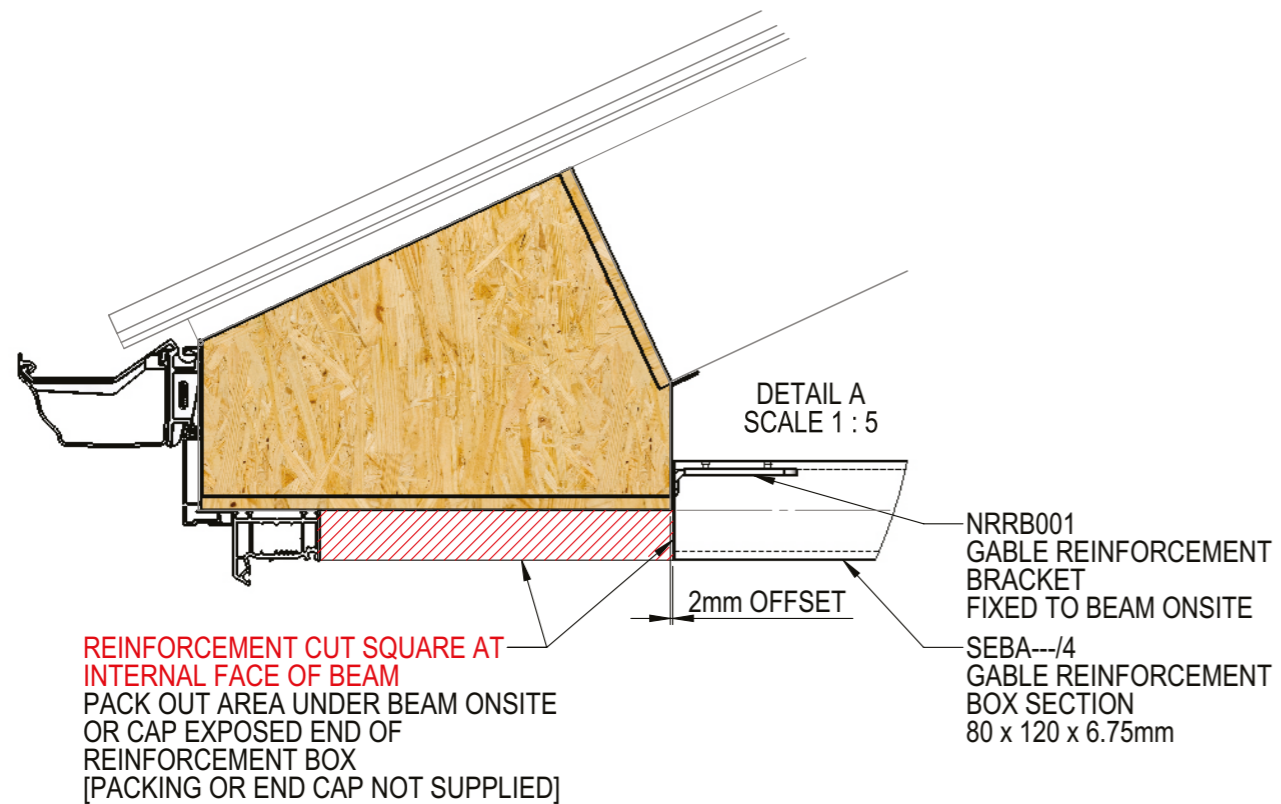

GABLE SYSTEM OVERVIEW - SECTION THROUGH STANDARD SOFFIT

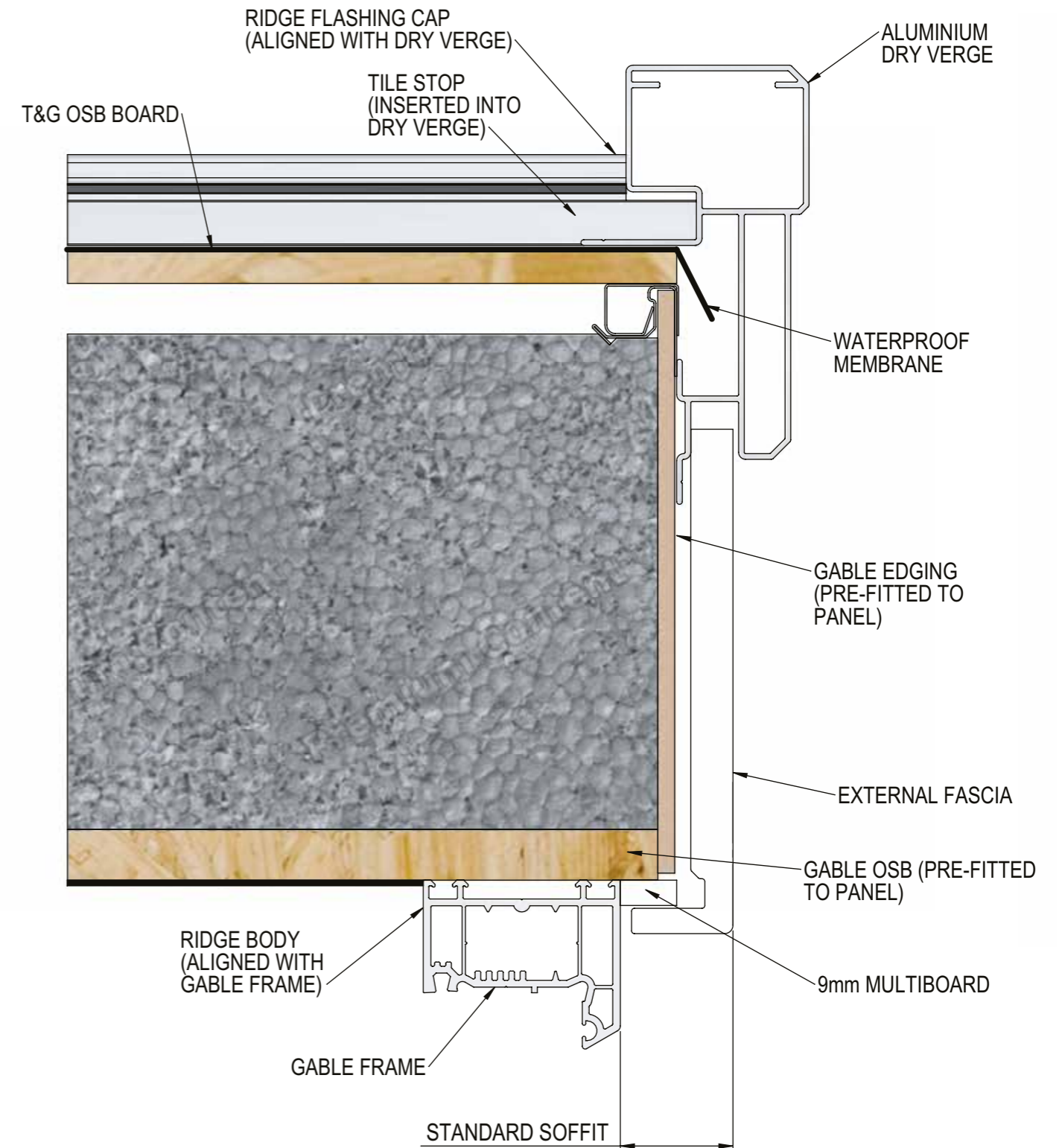

GABLE SYSTEM OVERVIEW
- SECTION THROUGH EXTENDED SOFFIT

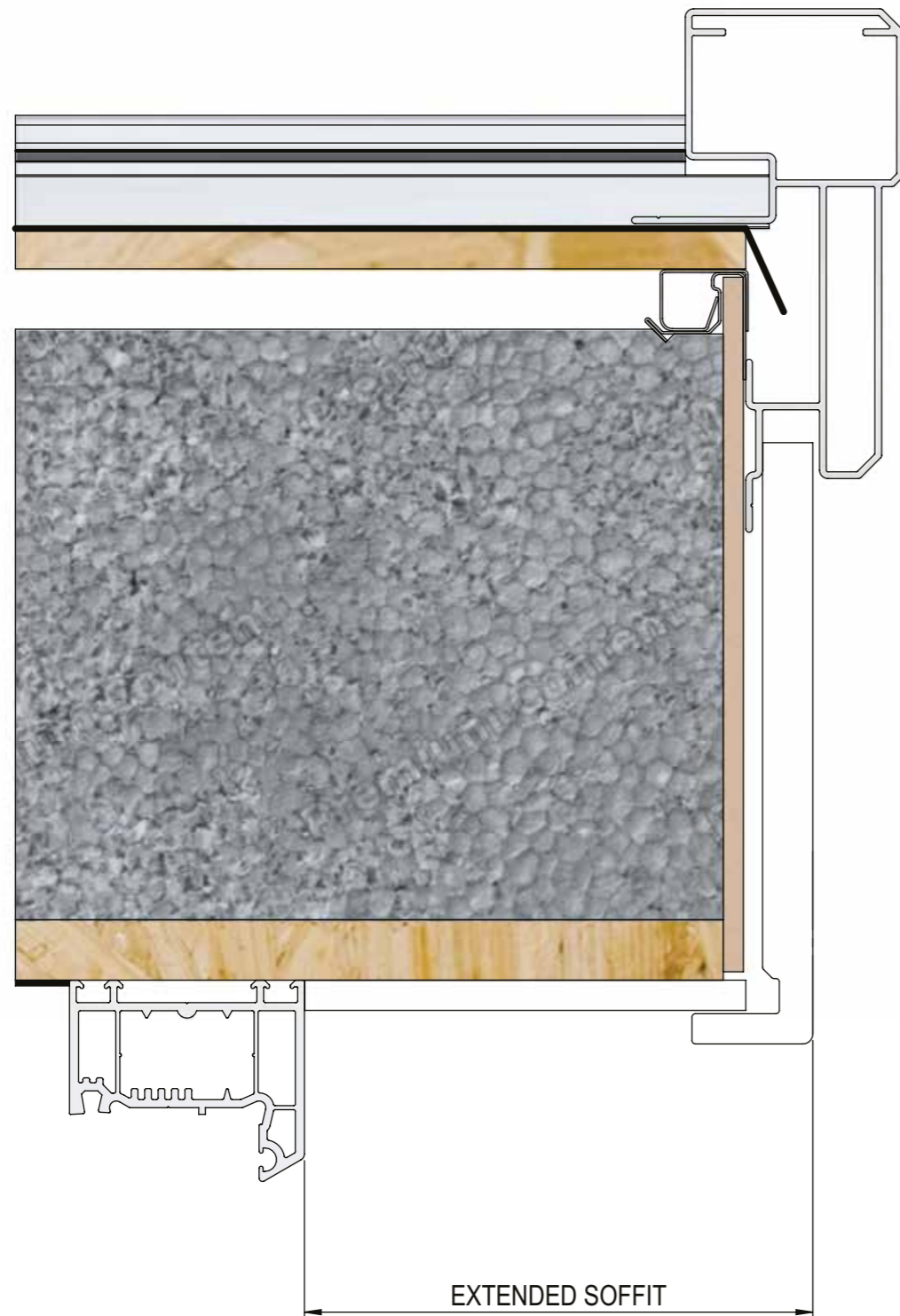

BOX BEAM ON SUPER-INSULATED COLUMN

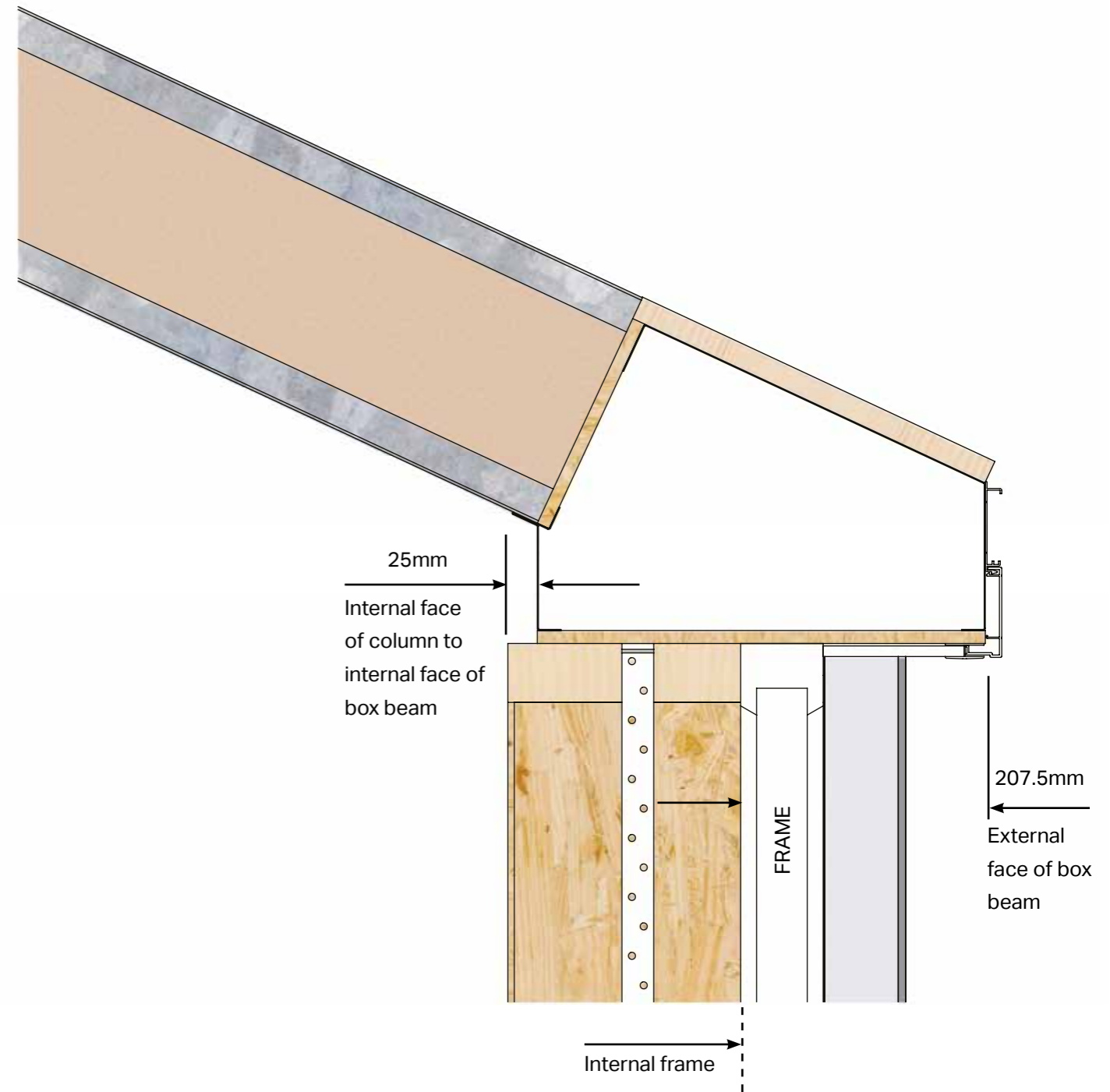

If your installation contains a super-insulated column, then it is possible to support the box beam on the column providing that the beam is installed with the following details.

INSTALLATION - INTERNAL/EXTERNAL FINISH - TUDOR



1
NO MATERIALS SUPPLIED FOR THIS FINISH. Attach corner beam support shelf



2
Batten out to suit plasterboard fixing.



3
Attach additional battens.



4
Slide into position additional external OSB board.



5
Fix into position.



6
Plasterboard the roof.



7
Fabricate 70 x 45mm triangular studding framework to suit.



8
Fix into place.



9
Attach additional mating timber battens.

INSTALLATION - INTERNAL/EXTERNAL FINISH - TUDOR



10
Insulate void with mineral wool.



11
Plasterboard face of gable



12
Fit external soffit channeling.



13
Fit external ship lap cladding edge channel.



14
External ship lap cladding edge channel detail.



15
Cut and fit ship lap to suit.

INSTALLATION - BEAM JOINING POST

This document shows how to join two Ultraroom Beams that are over 7m+ onto a stanchion post.

PLEASE READ BEFORE FITTING

SUPPLIED COMPONENTS

Below shows the various components that should be supplied as a beam joining on post kit.

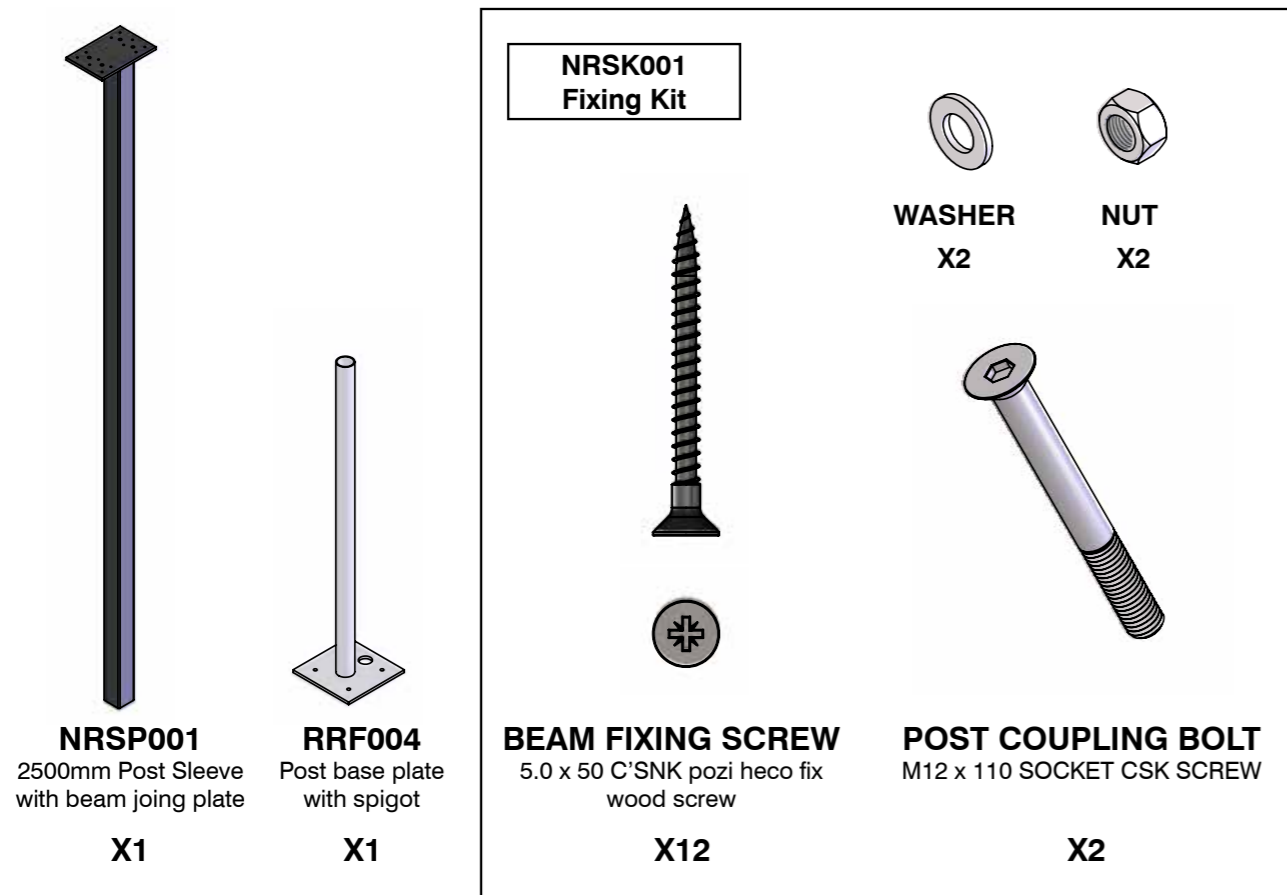

FITTING THE POST

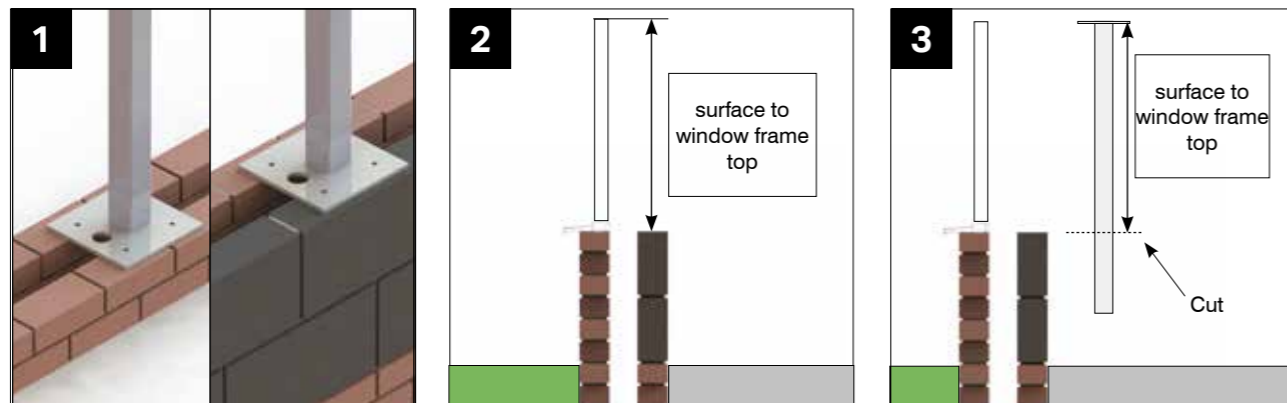

NOTE:
The post can be placed either at floor level or on top of a dwarf wall. Guide will show instruction from dwarf wall level.

Measure from the surface the post will sit on to the top of the window frames, this will drive the length of the post sleeve (NRSP001)

Cut the post sleeve (NRSP001) to the length measured in step 1

INSTALLATION - BEAM JOINING POST

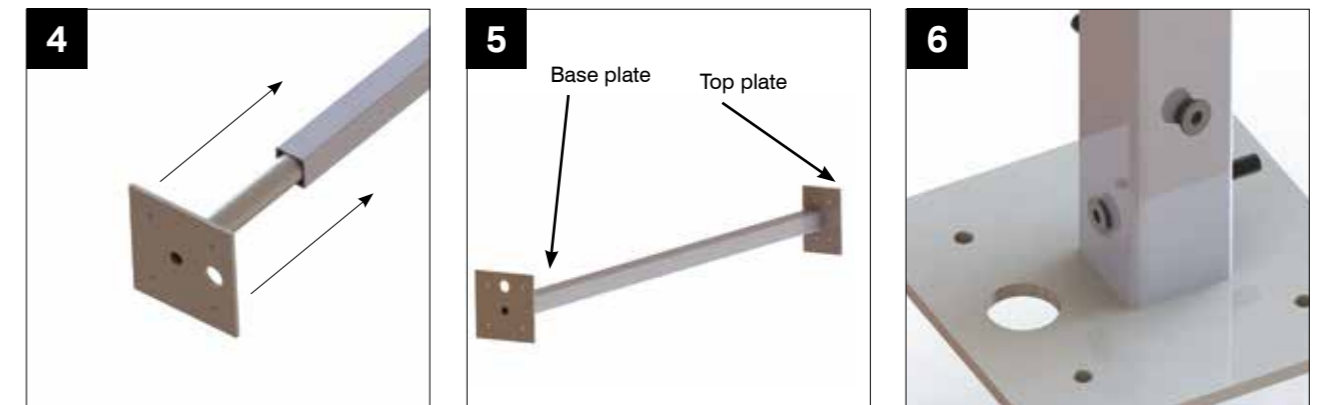

Slide the base plate (RRF004) all the way into the cut post sleeve.

Align the two sections as shown in the image above.

Secure the two sections together using the fixing bolts provided. Drill a 13mm hole through both sections and counter sink, secure with nuts provided.

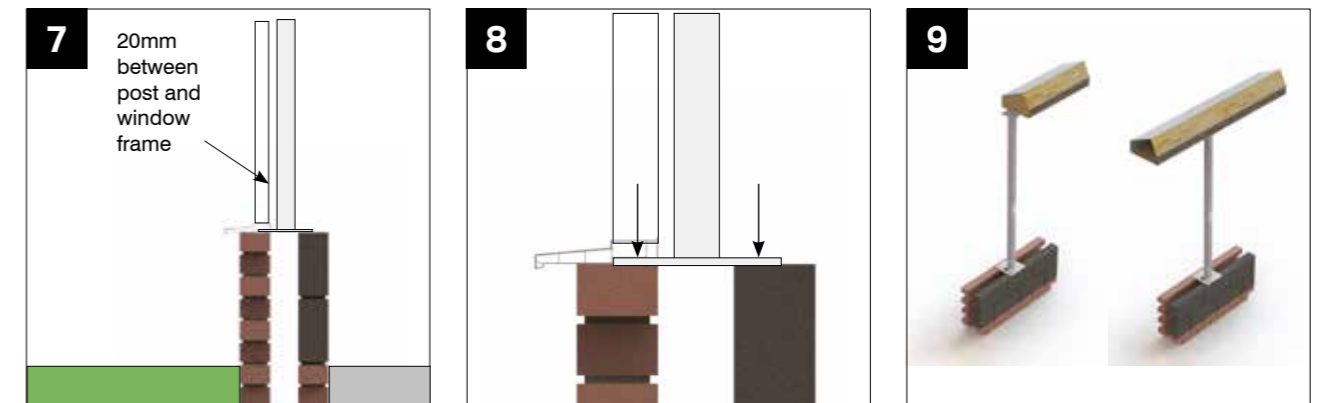

Offer up the post onto the brickwork; maintain a 20mm gap between the post and the external brick internal/window frame. Make sure the post is in the correct orientation. (SEE STEP 1)

Fix the post into the brick (FIXING NOT SUPPLIED)
NOTE: CILL MAY REQUIRE NOTCHING

Once secured, place the first box beam onto the post followed by the second beam.

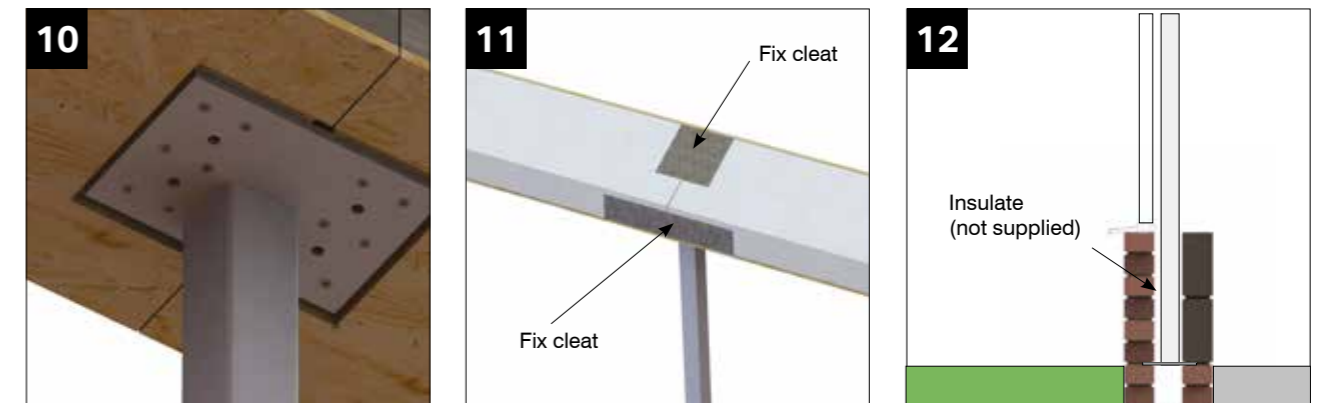

Once both beams are in place, secure the post into the beams. (Fix through the 12 counter sunk holes using the screws provided.)

Use the extra cleats provided to secure through the metal sections of the box beam. (see above image)

Insulate between the post and the external brick when post is set within the cavity wall.

INSTALLATION - SOIL PIPES



1 It is possible to modify our new panel on site to overcome obstructions at the host wall such as existing soil pipes.

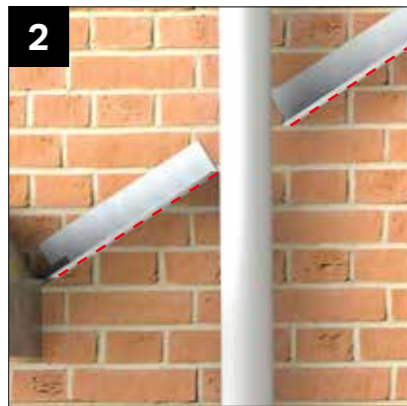

2 The ridge support starter bar must be split around the obstruction as shown in the example above.



3 A 20mm thick timber packer should then be placed onto the starter bar to support the panel. A 50 x 50 timber batten positioned correctly and screwed to the host wall will offer support to the OSB roof covering (see diagram in next step).

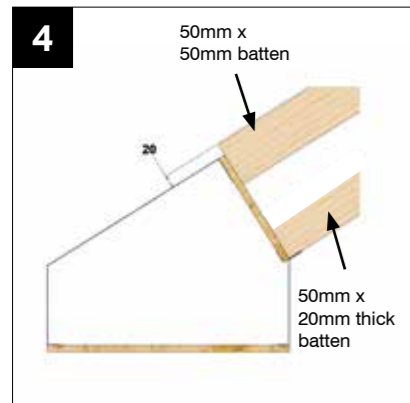

4 This diagram shows the positions of the required timber battens. Please note that the panel will require notching to accommodate the upper OSB support batten.

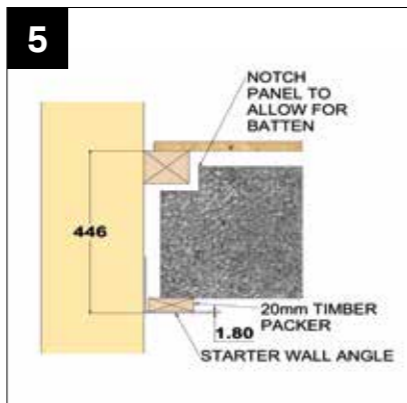

5 NOTE: The top face of the timber batten set 446mm from the lower face of the starter bar timber batten.

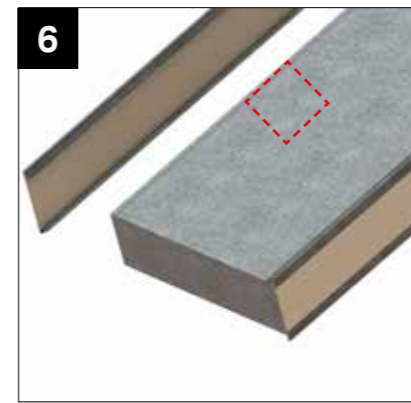

6 After releasing the retaining straps, remove one panel side and dispose of appropriately. Cut a slot through the panel to accommodate the obstruction.



7 Fit the first panel as shown and continue to fit all remaining panels as usual.



8 This view shows the Panel being properly supported at the host wall and the timber correctly positioned to support the OSB.

DUO PITCH - SOIL PIPES



1 If a soil pipe was specified with U-design at the point of order, the panel to accommodate this at the host wall will be prepped in our factory.

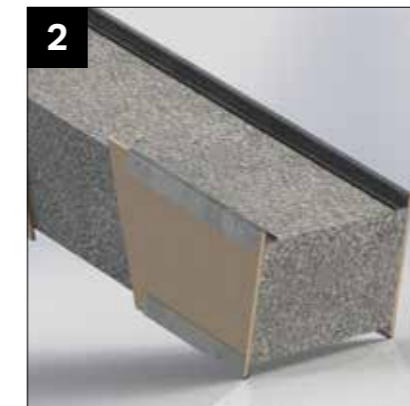

2 The panel side adjacent to the wall will be split around the pipe requiring only the PS to be cut on site to allow it to pass through the roof.



3 OSB should be cut on site as shown before installing the breather membrane.



4 If the tile sheets naturally split across the soil pipe apron (not supplied) as shown, install the lower tile sheet beneath the apron.



5 Next, install the upper tile sheet over the apron to allow proper shedding of water and cut around the pipe as shown.



6 If alternatively a whole tile sheet extends above and below the apron, cut the tile as shown to allow the apron to flow above the lower tiles.



7 Finish the edges of the cut tiles with the supplied powder coated frames.

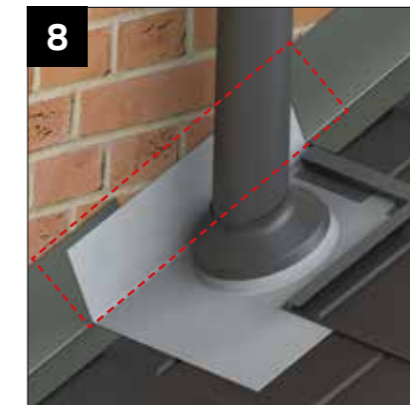

8 Structure the leadwork against the host wall as illustrated to allow proper shedding of water and install additional lead flashing behind the pipe (shown dotted) to finish

LEAN-TO - SOIL PIPES



1 If a soil pipe was specified in U-Design at the point of order, your half ridge assembly will be split as shown.

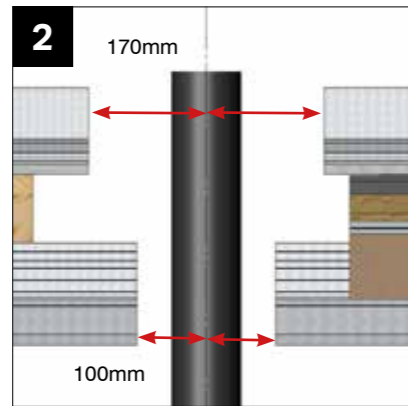

2 These should be installed in the usual manner paying attention to the setout dimensions as illustrated above



3 The "pipe" panel is cut on site to accommodate the pipe passing through the roof, and the OSB also requires an aperture cut (see inset image).



4 Install soil pipe flashing apron (not supplied) over the breather membrane. If your roof features glazing install the tile stop and aluminium flashing cap at this stage at 170mm from pipe centreline.



5 If your roof features glazing, flash ends of aluminium flashing caps with butyl patch (supplied) as shown. Cut the patch in half and mould carefully around the contours of the aluminium profiles to form a watertight seal

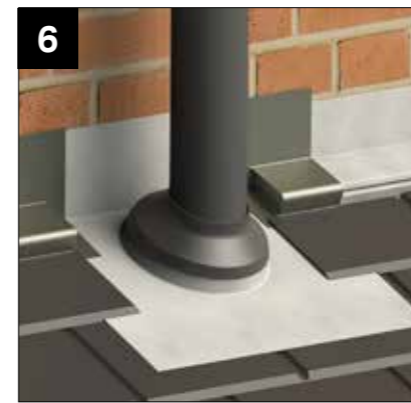

6 Cut the adjacent tile sheet allowing the pipe flashing apron to flow above the lower tiles as shown – this ensures the correct flow of any shedding water above the tiles.

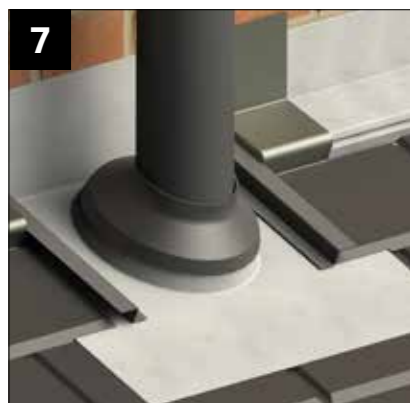

7 Finish with the powder coated rails (supplied) to conceal the cut tile edges before completing the lead detail to finish

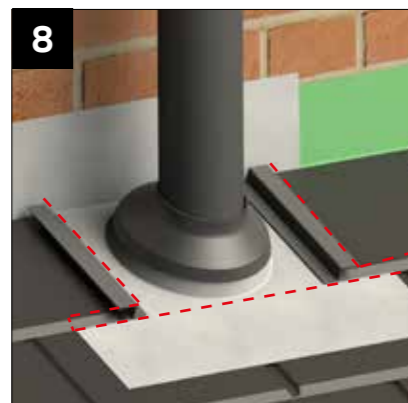

8 A solid roof assembly will look as shown and lead detail comes down the wall directly on to the tiles. Tile cut shown in red.

INSTALLATION - WASTE PIPES

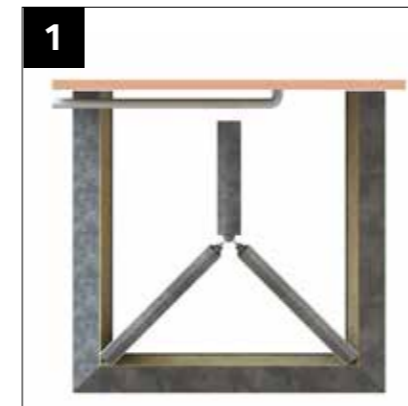

1 In this example, the position of existing pipework means that the ridge cannot be anchored back to the host wall in the usual manner. In this case, a framework must be constructed on which to mount the ridge. This can be done in 2 different ways.

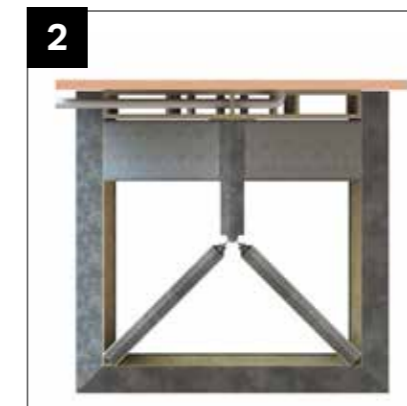

2 The first option is to construct a truss to support the ridge away from the host wall which runs the full length of a panel.



3 The ridge support starter bar can still be used to set out the ridge, and panel installation is carried out in the usual manner forward of the truss.



4 The fitter is responsible for insulating the cavity appropriately.



5 The second option uses a smaller, more localised ridge support as shown.

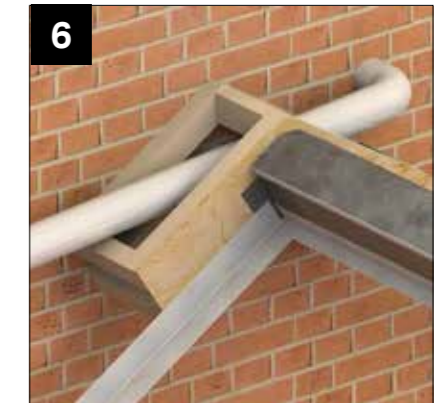

6 The ridge support starter bar can still be used to set out the ridge. This can then be removed and cut down to support the panel at the host wall as shown in the next step. Please refer to diagram for setout dimensions.



7 After releasing the banding, remove the panel side and dispose of appropriately. Cut out a portion of the panel to fit around the ridge support and install as shown.



8 The fitter is responsible for insulating the cavity appropriately.

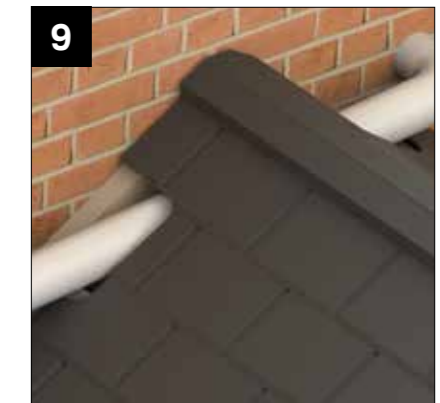

9 The fitter is responsible for cutting the tiles and OSB around the obstruction and flashing appropriately.

IMPROVED HIP ASSEMBLY - VARIABLE PITCHES

Your Ultrarof beams have been developed further and now allow for improved pitch difference capability. Roofs with this capability will incorporate beams that look different at the mitres. In some instances the difference compared with an equally pitched roof may be quite dramatic. This is perfectly normal and expected when your roof has different pitches at each beam.

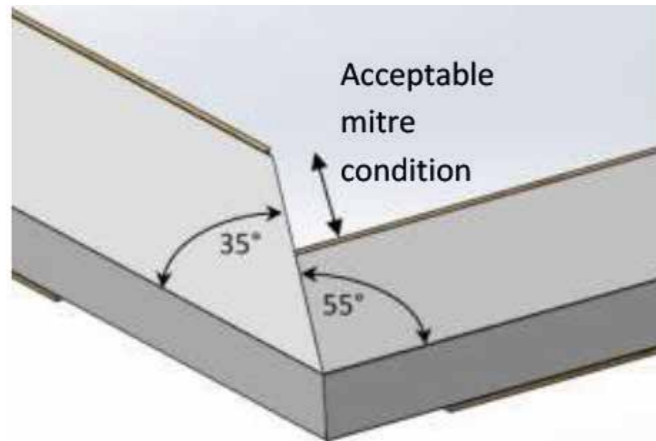

The image above shows an example of the final finish achieved internally for roofs with beams of the type shown on this page. **NOTE: the lowest pitch internal beam face will always require additional battening to bring inline with the steepest pitch beam face prior to plaster boarding.**

Viewed externally this graphic represents the jointing condition of two different pitch beams. The overall beam width is the same whilst the mitre lengths are different due to the mitre angle not being equal. **NOTE: the box beam, external mitre and upper face should always be inline.**



In variable pitch situations the beam setout shelf is asymmetric, with the longest side relating to the beam with the steepest pitch – see location plan.

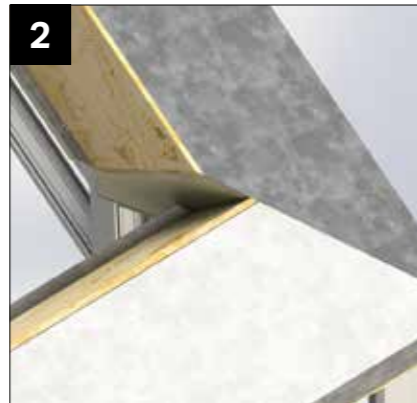

The assembled varying pitch beams will look something like the example shown. **NOTE: variable pitched beams will always be staggered on the internal face.**



The hip assembly features a notched beam overhang and offset hip wings. The notch should be oriented towards the beam with the steeper pitch.

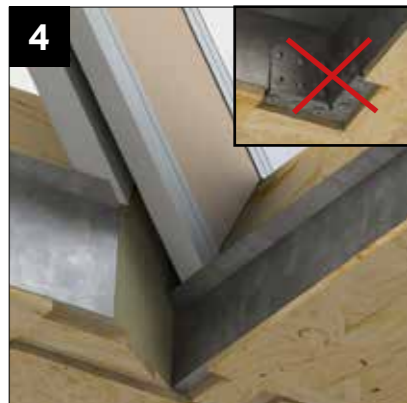

When in position, the offset hip wings should sit on the beam panel shelves as shown and be fixed as described in the main installation guide. **NOTE: INTERNAL BEAM CORNER CLEATS NOT SUPPLIED IN VARIABLE PITCH SITUATIONS.**



Fix the hip down into the beam through x 4 pre-drilled holes using WPCS020 (supplied). **NOTE: the external box beam cleat is still required.**

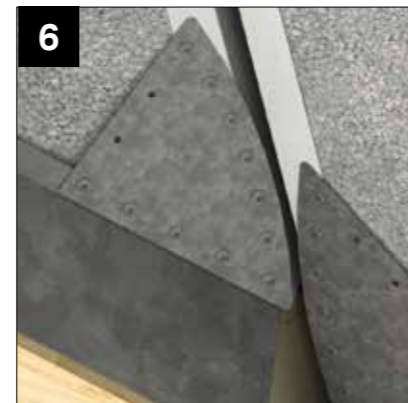

Position and fix the internal hip retaining plates using 18 x CHAA 006 screws provided. **NOTE: THE ORIENTATION OF THE PLATES CAN BE CHANGED TO ALLOW FOR OPTIMUM FIXING AS SHOWN.**

LEAN-TO HIPPED ENDS



A hipped end ridge will be supplied with a hip support bracket pre-fitted as shown. **(Please note: the OSB and upper aluminium part will only be supplied if the roof is glazed).**

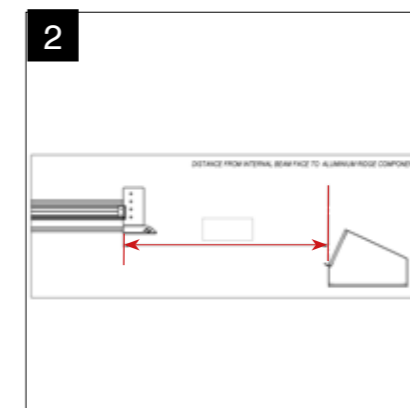

See critical dimensions sheet for correct positioning relative to adjacent beam.

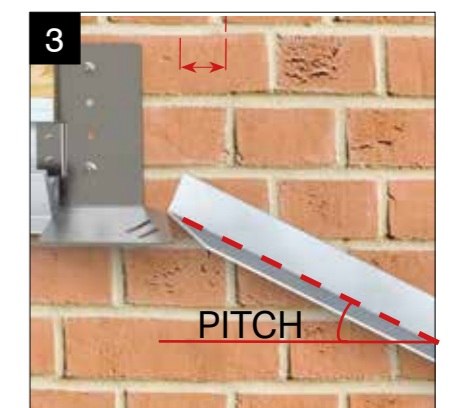

Install wall support angle by engaging beam bracket in the usual manner (see standard install guide), and set to facet pitch.



Install hip by resting its wings across the support bracket and wall support angle.



Internal view of hip position.

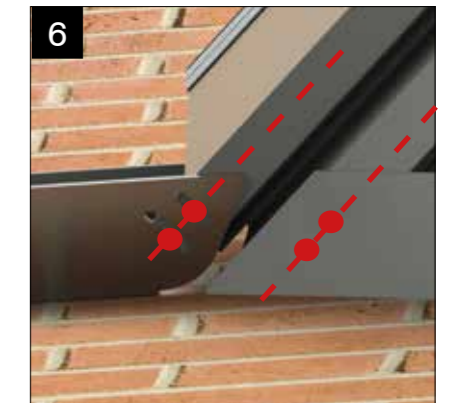

Drill 2 X 6.5mm holes per hip along the centreline of each wing as shown. Where support bracket is present, drill through pre existing slots.

WRAPAROUND RIDGE (EXTERNAL 90° CORNER)



Secure the hip using low profile bolts and flange nuts provided in the orientation shown.



In the case of a wraparound ridge, a handed pair of hip support brackets interact as shown. **(Please note: the OSB and upper aluminium part will only be supplied if the roof is glazed).**

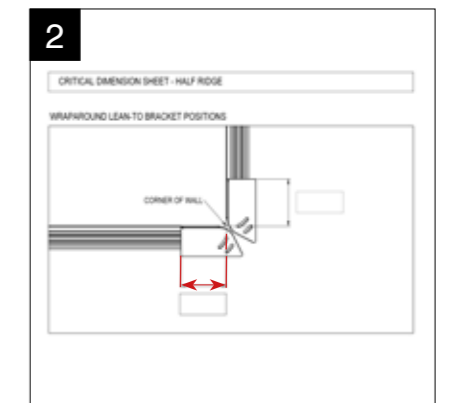

See critical dimensions sheet for correct positioning relative to corner of wall.

www.ultraframetrade.co.uk

Ultraframe[®]
Transforming light and space

Job No.: 4047 03/21 V4 WPIG003

It is Ultraframe's policy to continually seek to improve its products, processes and services, and we reserve the right to change specifications without prior notice. Ultraframe is a trading name of Ultraframe (UK) Limited.