

READ BEFORE FITTING

FAILURE TO FOLLOW THESE INSTRUCTIONS CAN RESULT IN TEMPORARY DISTORTION WHICH MAY MEAN TILES WILL NEED TO BE RELAID. Following these instructions allows tiles to correctly 'float' for expansion and contraction.

1. ENSURE TILES ARE FITTED TO THE CORRECT INSERTION LINE – **DO NOT PUSH TILES TOGETHER.** Insertion lines vary according to temperature when installed
2. **DO NOT OVERTIGHTEN SCREWS**

The NRTT001 Tile Screw Fixing Tool can be found with the NRTF050 screws inside the fixings component box.

Hold the tool in place as shown whilst installing each screw and remove to ensure a fit which is close but not too tight – This is to allow for the expansion and contraction of the tiles.

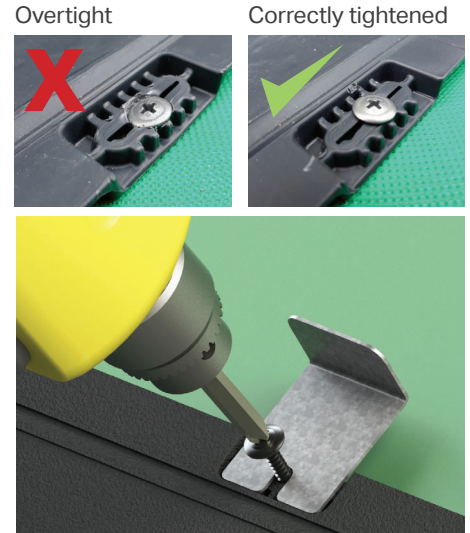
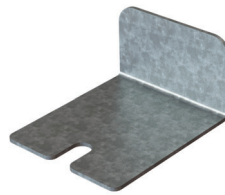

Tile starter strips are lettered in correspondence with its location shown in the tile location plan. **TILE STARTER STRIPS ARE NOT FITTED IN ALPHABETICAL ORDER, PLEASE FOLLOW INSTALLATION SEQUENCE ON THIS PAGE FOR CORRECT FIT.**

GLAZED ROOF

Details shown also apply to Victorian shapes.

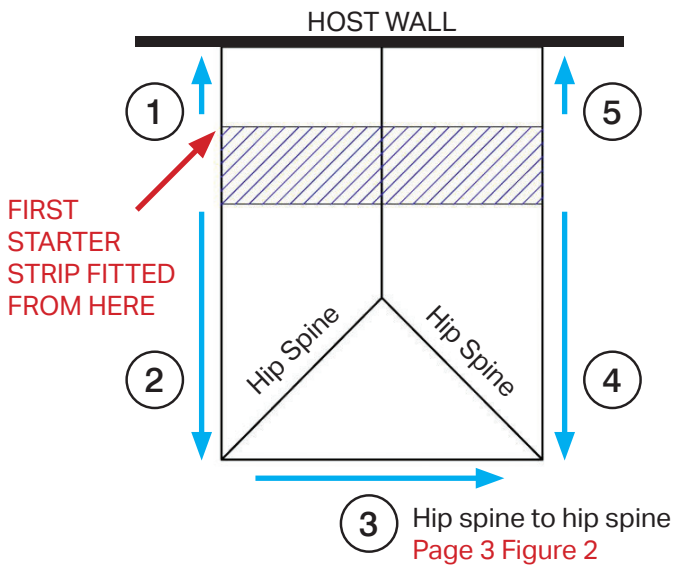

If a roof contains rectangular glazing panels, starter strips must be set out from the glazing bar centre. **(See page 3 figure 1)**

SOLID ROOF

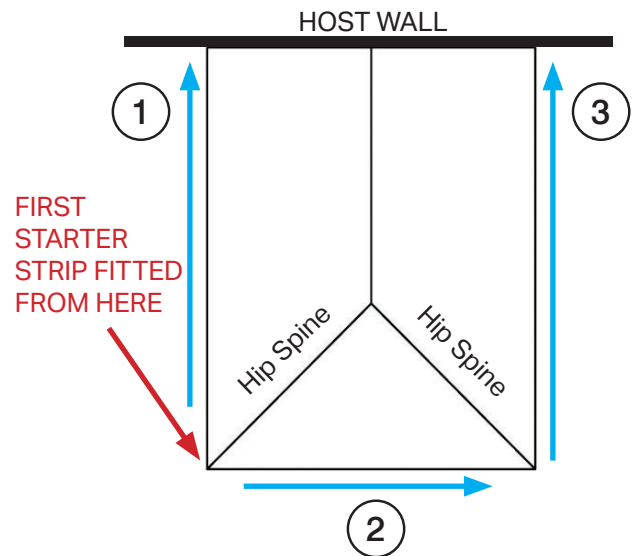

If a roof contains no rectangular glass panels and is classed as 'solid' then starter strips must be set out from the hip spine. **(See page 3 figure 2)**

KEY
Fitting order is labelled 1 to 5
Direction of starter strip fitting →

KEY
Fitting order is labelled 1 to 3
Direction of starter strip fitting →

INSTALLATION - FITTING STARTER TILE STRIP

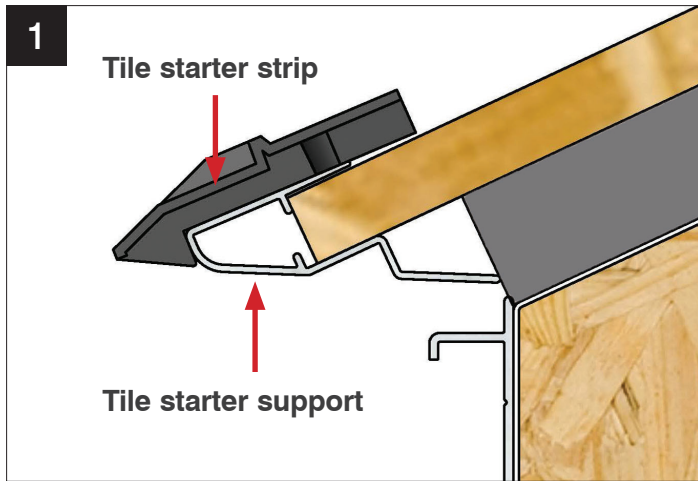

Place starter tile strip on starter tile support, make sure strip is a tight fit up against support.

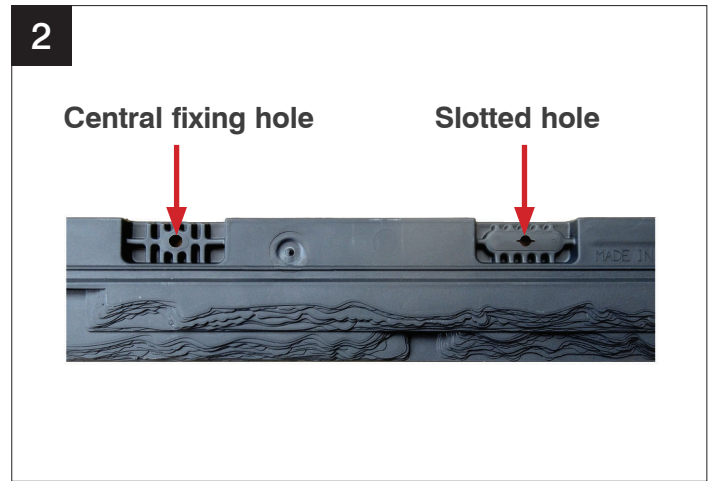

Fix through the central fixing hole for temporary fitting. **(DO NOT FIX THROUGH SLOTTED HOLES UNTIL ALL STARTER STRIPS ARE IN PLACE)**

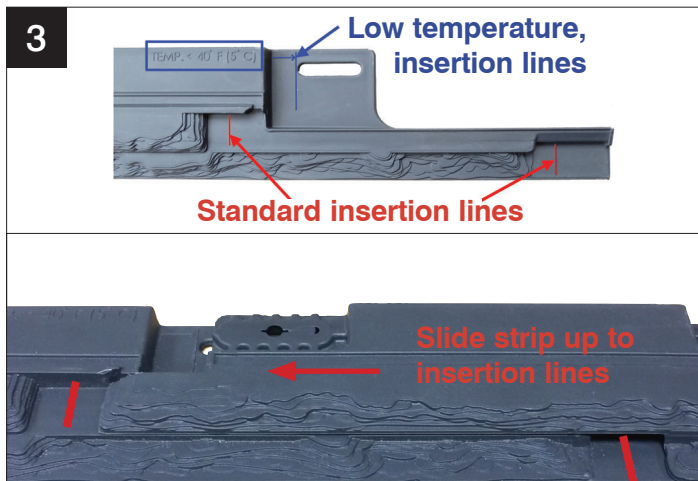

Following the direction stated in the fitting guide (see p1). Align next starter tile strip with the standard insertion lines.
NOTE: IF AIR TEMPERATURE IS BELOW 5°C, ALIGN WITH THE LOW TEMPERATURE LOCATION MARK (TOP RIGHT OF STRIP)

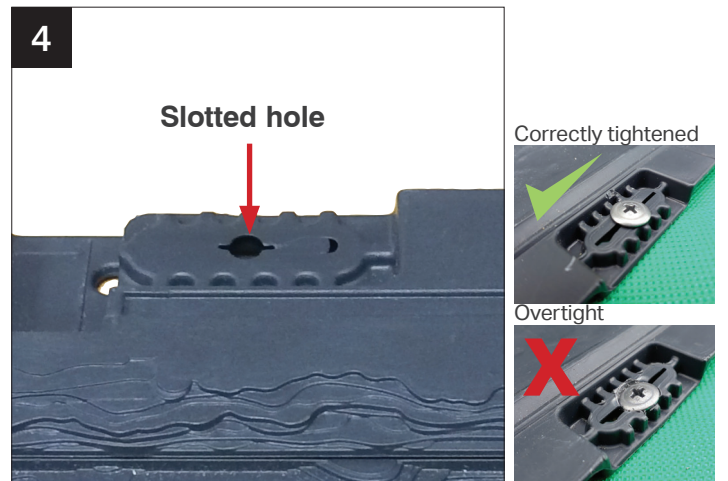

Repeat steps 3&4 following the fitting order guide until all starter strips are in place and are correctly fitted. Once correct, fully fix through slotted holes along the starter strips for permanent fix.

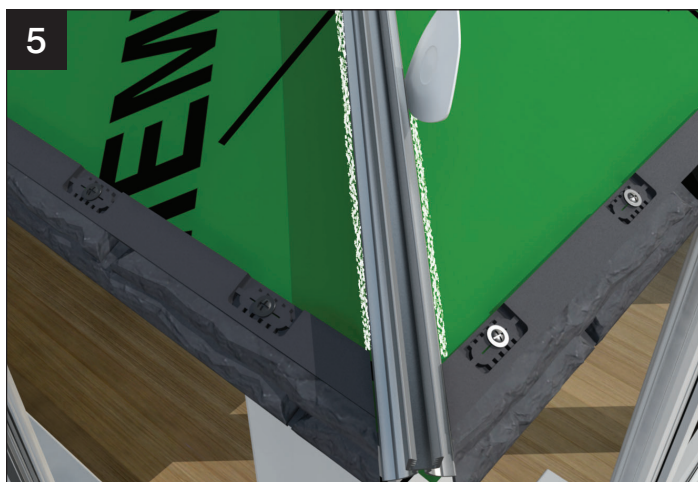

Mark position of hip spines and remove from roof, this helps with fitting of the tile panels.

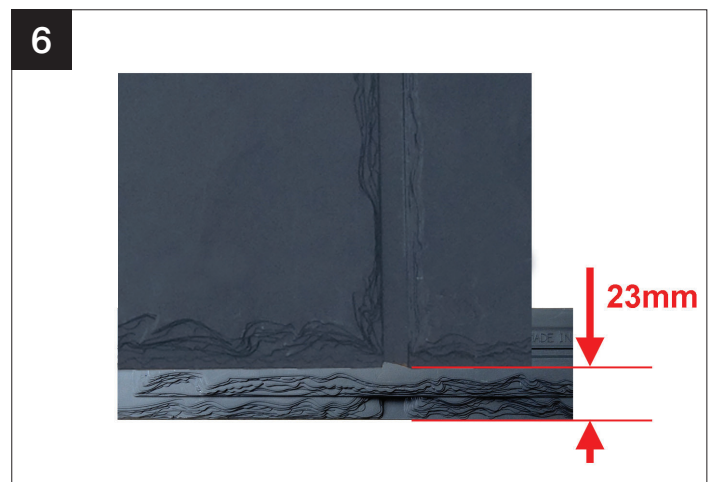

Using the tile location plan provided, locate position of first tile panel (labelled aa1), slide down onto the starter strip leaving 23mm from the starter strip edge. This allows expansion of the tiles in warm temperatures.

INSTALLATION - FIXING TILE PANEL

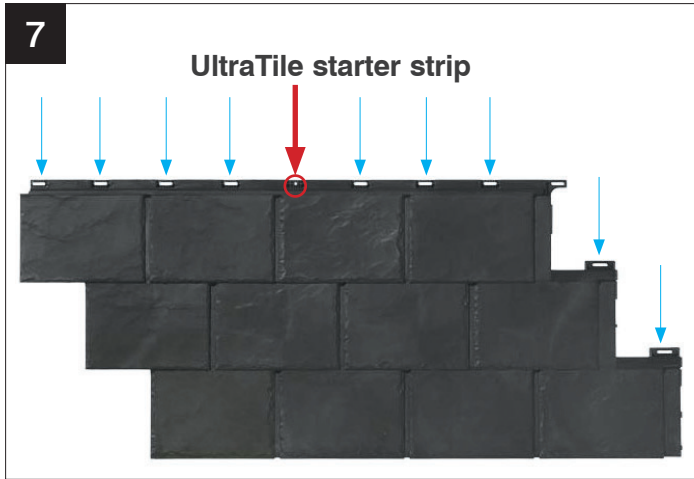

STEP 1 – fix through central non adjustable fixing hole
STEP 2 – fix through remaining slotted holes (10 holes)

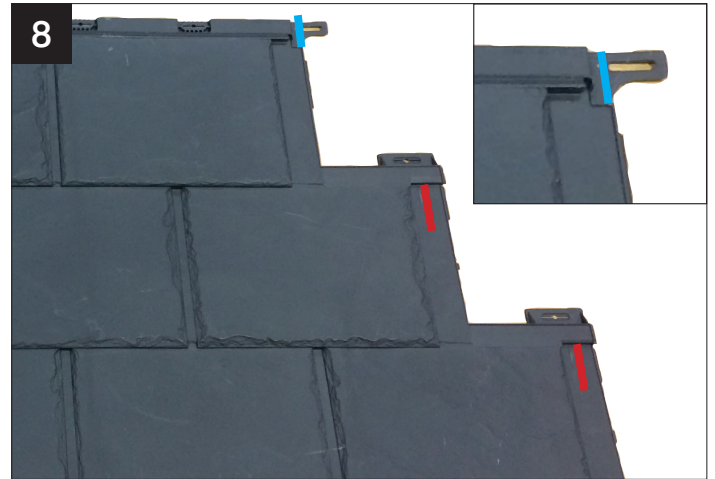

At normal temperatures, of around 15°C, use the insertion lines indicated red in the image.
 For low temperature installations, below 5°C, use the single insertion line indicated blue, at the top right of the tile.

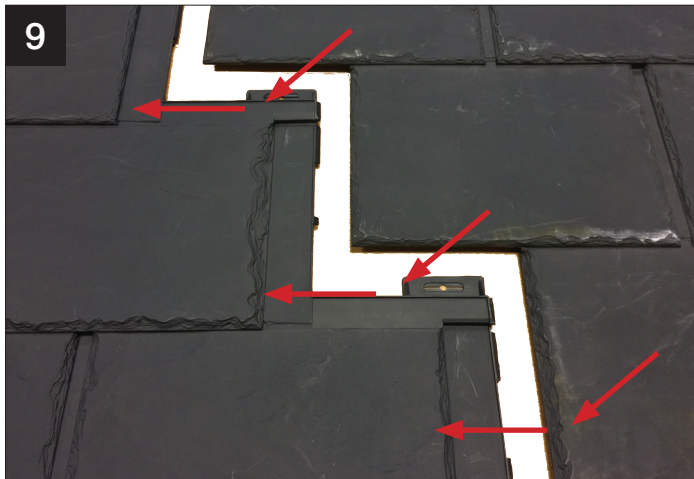

To slot the tiles together a down and left action is used in one movement. Make sure all tabs have interlocked. Tiles are fitted to the roof from left to right bottom to top. Repeat steps 7, 8 and 9 for entire layer.

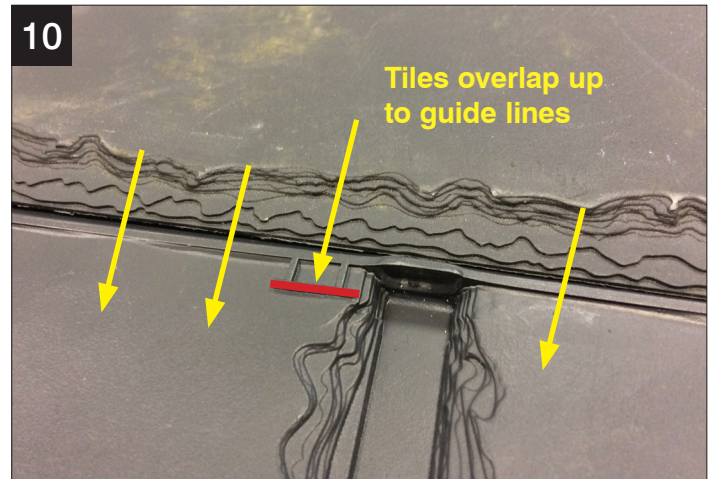

When inserting next layer, overlay tiles in line with insertion lines (marked in red above) on the tile. Repeat steps 8, 9 and 10 until the roof is fully tiled. See tile finishing references on back for accurate fit and best results.

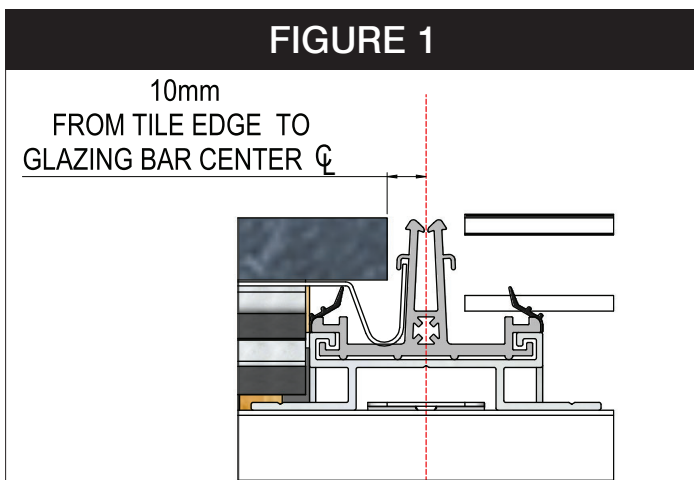

If the roof contains full rectangular glass panels, the starter strips **MUST** be fitted from the glazing bar.

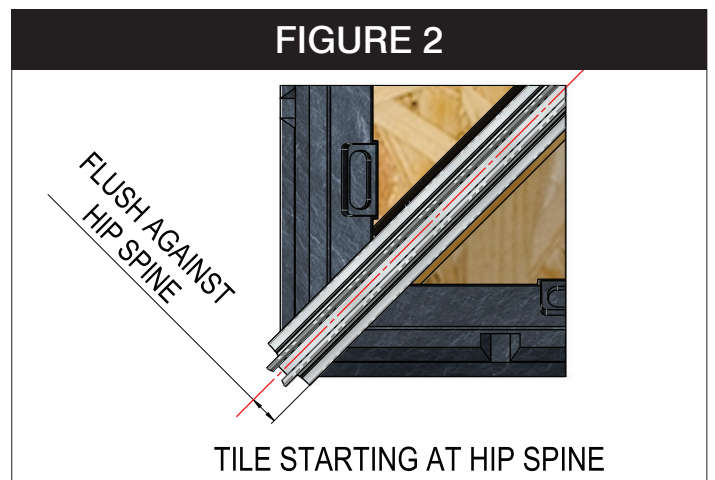

If the roof contains no rectangular glass panels, then the starter strips **MUST** be fitted at the hip spines first.

FOR MORE DETAILED INSTALL OF TILES, PLEASE READ THE FULL INSTALL GUIDE FOR ULTRAROOF

INSTALLATION - TILE FINISHING REFERENCES



Distance from bottom tile edge to tile overlap insertion lines.

This is the amount of tile that should be visible on each layer of the roof. This is a good check to see if the tiles are in the correct position with correct spacing allowances for heat expansion.

REFERENCE DIMENSIONS ONLY - NOT SET OUT DIMENSIONS - site conditions may cause these dimensions to vary.

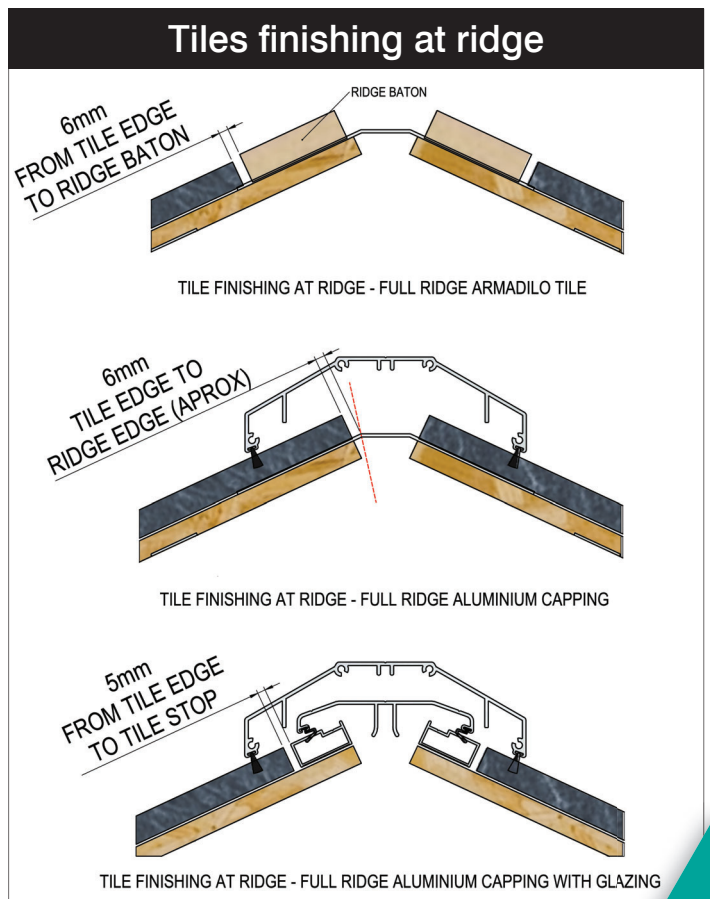
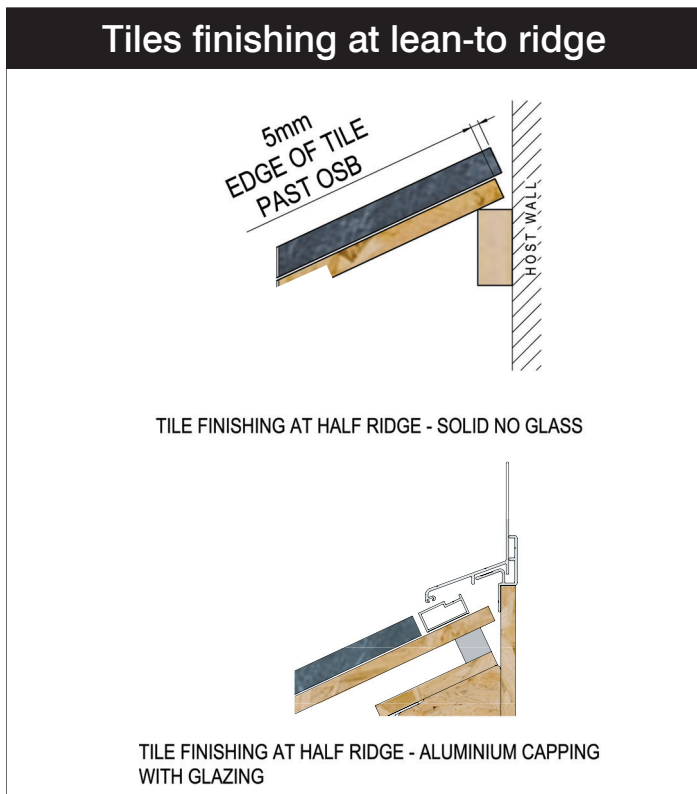
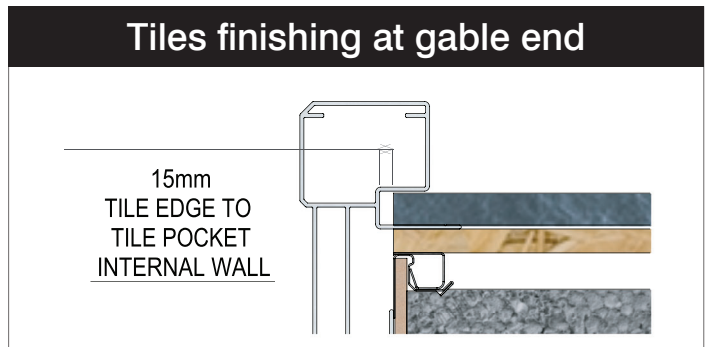
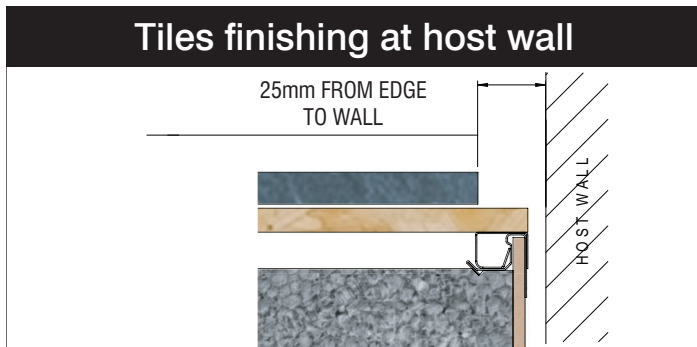

FOR MORE DETAILED INSTALL OF TILES, PLEASE READ THE FULL INSTALL GUIDE FOR ULTRAROOF